

H.E.L.P. Plasmate[®] Futura

Instructions for Use SW 3.0x



H.eparin induced
E.xtracorporeal
L.DL
P.recipitation

B | BRAUN
SHARING EXPERTISE

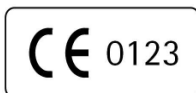

CE-marking according to guideline 93/42/EWG
Technical alterations reserved

Art. No. 38910323ENCA / Rev. 3.03.00 / February 2015

B | BRAUN
SHARING EXPERTISE

B. Braun Avitum AG

34209 Melsungen
Germany

www.bbraun.com

Contents

1	Safe Handling	3
1.1	ABOUT THESE INSTRUCTIONS FOR USE	3
1.1.1	Validity	3
1.1.2	Target Group for the Instructions for Use	3
1.1.3	Warnings, Notices and Symbols in These Instructions for Use	3
1.1.4	Abbreviations	4
1.2	INTENDED USE AND INDICATION	5
1.3	CONTRAINDICATIONS	5
1.4	SIDE EFFECTS	6
1.5	SPECIAL HAZARDS AND PRECAUTIONS	7
1.5.1	Special Patient Conditions	7
1.5.2	Electrical Hazards	8
1.5.3	Grounding Reliability	8
1.6	INTERACTION WITH OTHER DEVICES	8
1.6.1	Electromagnetic Interaction	8
1.7	INFORMATION FOR THE OPERATOR	9
1.7.1	Training by the Manufacturer Prior to Commissioning	9
1.7.2	Requirements on the User	9
1.7.3	Conformity	9
1.7.4	Manufacturer's Responsibility	9
1.7.5	Technical Changes	10
1.8	DISPOSAL	10
2	Product Description	3
2.1	PRINCIPLE	3
2.2	FUNCTION	4
2.3	MACHINE	6
2.3.1	Front View	6
2.3.2	Upper Module	7
2.3.3	Central Module	8
2.3.4	Control Buttons on the Central Module	9
2.3.5	Rear of the Machine	10
2.4	SYMBOLS ON THE H.E.L.P. PLASMAT® FUTURA MACHINE	11
2.5	MONITOR	12
2.5.1	Monitor Controls	12
2.5.2	Keys for Operating the Blood Pump	13
2.5.3	Monitor Layout and Functions	13
2.6	CONSUMABLES	17
2.6.1	H.E.L.P. Futura Set	17
2.6.2	Solutions	18
3	Preparation	3
3.1	SWITCHING ON AND SELFTEST	3
3.1.1	Switching on the Machine	3
3.2	PREPARING THE SOLUTIONS	3
3.3	SETTING UP THE BAGS	5
3.4	SETTING UP THE H.E.L.P. FUTURA SET	6

4	Priming and Rinsing	3
4.1	AUTOMATIC PRIMING AND RINSING	3
4.2	PARAMETER SETTING	10
4.2.1	Parameter Setting in the <Main Parameter> Screen	10
4.2.2	Parameter Setting in the <Parameter Overview> Screen	14
4.2.3	Parameter Setting in the <Flow Scheme> Screen	18
4.2.4	Additional Functions	19
5	Therapy	3
5.1	STARTING THE THERAPY	3
5.1.1	Starting the Blood Circuit	6
5.1.2	Starting the Plasma Circuit	6
5.2	TERMINATING THERAPY	7
5.3	PARAMETER SETTING	9
5.3.1	Parameter Setting in the <Main Parameter> Screen	9
5.3.2	Parameter Setting in the <Parameter Overview> Screen	11
5.3.3	Parameter Setting in the <Flow Scheme> Screen	14
5.4	ADDITIONAL FUNCTIONS	15
5.4.1	Premature Termination of Therapy	15
5.4.2	Premature Termination of Therapy by Power Failure	16
5.4.3	Additional Functions	17
5.4.4	Heparin Bolus	19
6	Reinfusion	3
6.1	PLASMA REINFUSION	3
6.2	BLOOD REINFUSION	6
6.3	TERMINATING THE TREATMENT	7
6.4	PARAMETER SETTING	9
6.4.1	Parameter Setting in the <Main Parameter> Screen	9
6.4.2	Parameter Setting in the <Parameter Overview> Screen	11
6.4.3	Parameter Setting in the <Flow Scheme> Screen	14
6.4.4	Additional Functions	15
7	Basic and Default Settings	3
8	Selftests, Alarms and Problem Correction	3
8.1	SELFTEST	3
8.1.1	Hardware Selftest	3
8.1.2	Selftest Duration and Alarm Code	6
8.2	DYNAMIC TESTS AND CONTROLS DURING THERAPY AND REINFUSION	12
8.2.1	Blood Leak Detection	12
8.2.2	Connection Test in Therapy and Reinfusion	13
8.2.3	Control of Ultrafiltration	13
8.3	ALARMS	14
8.3.1	Alarm Concept	14
8.3.2	List of Alarms	16
8.4	WARNINGS	29
8.4.1	Warning Concept	29

8.4.2	List of Warnings.....	31
8.5	PROBLEM CORRECTION	38
8.5.1	Balance Reset.....	38
8.5.2	Deaeration of the Heparin Adsorber.....	40
8.5.3	Changing the Solution Bags	40
8.5.4	Changing the Plasma Filter	42
8.5.5	Changing the H.E.L.P. Precipitate Filter	43
8.5.6	Changing the H.E.L.P. Heparin Adsorber.....	44
8.5.7	Changing the H.E.L.P. Ultrafilter	45
9	Technical Information	3
9.1	TRANSPORT	3
9.1.1	Wheeling.....	3
9.1.2	Carrying.....	4
9.2	OPERATING CONDITIONS.....	5
9.2.1	Installation Site	5
9.2.2	Initial Commissioning	5
9.2.3	Service and Maintenance	6
9.2.4	Disposables, Consumables and Accessories/Replacement Parts.....	6
9.2.5	Cleaning and Disinfection.....	6
9.3	GENERAL TECHNICAL DATA	7
9.3.1	Recommended Safe Distances.....	8
9.4	TECHNICAL DATA – COMPONENTS	8
9.4.1	Relevant Pressures	9
9.4.2	Limits of Adjustable Parameters.....	11
9.4.3	Extracorporeal Blood Circuit.....	12
9.4.4	Plasma Circuit	15
9.4.5	Dialyzing Circuit	17
9.4.6	Weight System.....	19
9.5	WARRANTY AND LIABILITY	20
9.5.1	Manufacturer Responsibility.....	20
9.5.2	Warranty and Liability	20

1	Safe Handling	3
1.1	ABOUT THESE INSTRUCTIONS FOR USE	3
1.1.1	Validity	3
1.1.2	Target Group for the Instructions for Use	3
1.1.3	Warnings, Notices and Symbols in These Instructions for Use	3
1.1.4	Abbreviations	4
1.2	INTENDED USE AND INDICATION	5
1.3	CONTRAINDICATIONS	5
1.4	SIDE EFFECTS	6
1.5	SPECIAL HAZARDS AND PRECAUTIONS	7
1.5.1	Special Patient Conditions	7
1.5.2	Electrical Hazards	8
1.5.3	Grounding Reliability	8
1.6	INTERACTION WITH OTHER DEVICES	8
1.6.1	Electromagnetic Interaction	8
1.7	INFORMATION FOR THE OPERATOR	9
1.7.1	Training by the Manufacturer Prior to Commissioning	9
1.7.2	Requirements on the User	9
1.7.3	Conformity	9
1.7.4	Manufacturer's Responsibility	9
1.7.5	Technical Changes	10
1.8	DISPOSAL	10

1 Safe Handling

1.1 ABOUT THESE INSTRUCTIONS FOR USE

These instructions for use form an integral part of the H.E.L.P. Plasmac® Futura machine. They describe the appropriate and safe use of the H.E.L.P. Plasmac® Futura machine at all stages of operation.



The H.E.L.P. Plasmac® Futura machine must always be used in accordance with the instructions for use.

Always keep the instructions for use at the H.E.L.P. Plasmac® Futura machine for later use.

Pass on instructions for use to any future user of the H.E.L.P. Plasmac® Futura machine.

1.1.1 Validity

Art.-No.

These instructions for use apply to H.E.L.P. Plasmac® Futura machines with the article numbers (art. no.):

- 7062100
- 706210A (110 V/120 V)

Software version

These instructions for use apply to software version 3.0x.

1.1.2 Target Group for the Instructions for Use

The target group for these instructions for use is specialist medical staff.

The H.E.L.P. apheresis should be applied and supervised only by physicians with sufficient experience in the execution of extracorporeal procedures for blood purification.

The H.E.L.P. Plasmac® Futura machine may only be used by persons instructed for its appropriate operation.

1.1.3 Warnings, Notices and Symbols in These Instructions for Use

Warnings in these instructions for use point out particular hazards for users, patients, third parties and the H.E.L.P. Plasmac® Futura machine. They also suggest measures that can be taken to avoid the respective hazard.

There are three levels of warning notices:

Warning term	Meaning
DANGER	Imminent danger that can lead to death or serious injury if not avoided
WARNING	Potentially imminent danger that can lead to death or serious injury if not avoided
CAUTION	Potentially imminent danger that can lead to minor injuries or damage to equipment if not avoided

The warning notices are highlighted in the following manner (see below example for a CAUTION warning):

 CAUTION	<p>Here the type and source of the danger are listed, and possible consequences if measures are not followed!</p> <p>➤ This is the list of measures to prevent the hazard.</p>
---	--

	<p>This is the list of important information, directly or indirectly relating to safety and the prevention of damage.</p>
---	---

i

This is additional useful information concerning safe procedures, background information and recommendations.

➤ This symbol marks the instructions for action.

1.1.4 Abbreviations

BLD	Blood leak detector
BP	Blood pump
DAD	Dialysate air detector
DP	Dialysate pump
H	Plate warmer
HAK	Heparin adsorber clamp
HP	Heparin pump
LC	Load cell
PA	Arterial pressure
PBE	Prefilter pressure
PBP	Plasma/buffer pump
PDF	Dialyzer pressure
PDI	Dialysate inlet pressure
PDPA	Precipitate filter/adsorber pressure drop
PPF	Precipitate filter pressure
PPL	Plasma pressure
PV	Venous pressure
SAD	Safety air detector
SAK	Safety air clamp
TMP	Transmembrane pressure
UFP	Ultrafiltration pump

1.2 INTENDED USE AND INDICATION

The H.E.L.P. Plasmate Futura machine can be used for implementing and monitoring extracorporeal treatments of plasma. The system can be used for patient treatment in a hospital and health center when prescribed by a physician.



H.E.L.P. Plasmate Futura machine may only be used in combination with the H.E.L.P. apheresis treatment system from B. Braun Avitum AG.

The H.E.L.P. Futura apheresis system is indicated for use in performing low density lipoprotein cholesterol (LDL-C) apheresis to acutely remove LDL-C from the plasma of the following high risk patient populations for whom diet has been ineffective and maximum drug therapy has either been ineffective or not tolerated:

Group A:

Functional Hypercholesterolemic Homozygotes with LDL-C > 500 mg/dl;

Group B:

Functional Hypercholesterolemic Heterozygotes with LDL-C \geq 300 mg/dl; and

Group C:

Functional Hypercholesterolemic Heterozygotes with LDL-C \geq 200 mg/dl and documented coronary heart disease (CHD).

Documented CHD is defined as having one or more of the following:

- a prior documented myocardial infarction (MI);
- a prior coronary artery bypass graft surgery (CABG);
- a prior percutaneous transluminal coronary angioplasty (PTCA) with or without atherectomy or coronary artery stent placement; or
- significant angina pectoris with a positive thallium or other heart scanning stress test.

1.3 CONTRAINDICATIONS

The H.E.L.P. apheresis treatment must not be applied in the case of

- Hemorrhagic diathesis
- Ulcers in the gastrointestinal area
- Haemorrhage
- Coagulation disorder and neoplasm
- Liver diseases
- Severe heart failure and valvular defect
- Condition following apoplexia
- Dementia
- During pregnancy and lactation
- Children and infants in whose case the extracorporeal volume is a limiting factor.

The doctor in charge of the treatment is responsible for choosing the suitable therapy, based on medical and analytical findings and the general health and condition of the patient.

1.4 SIDE EFFECTS

Occasionally, the occurrence of angina pectoris has been observed.

In rare cases, there are

- Cardiovascular system: anginal pain, hypertension, hypotension, cardiac arrhythmias, vasovagal reactions
- Heart rhythm irregularities and labored breathing caused by the underlying disease
- Bradycardia
- Vasovagal syncopes
- Circulatory collapse
- Hypotonia
- Nausea/sickness
- Dizziness
- Headache
- Tiredness/exhaustion
- Tension and swelling of arms, hands and face
- Burning eyes
- Prolonged bleeding time
- Dyspnea
- Hypertonia
- Feeling hot, sweating
- Hypersensitivity reactions against the hydrophilic components of the tubing and filter material are generally rare in extracorporeal treatment procedures.
- flushing
- discomfort in treatment extremity
- hypotension
- decrease in ferritin levels

In isolated cases there is

- Iron deficiency anemia
- Hypertonia and oedema formation in the case of patients with renal function impairment

In rare instances benzyl alcohol can cause hypersensitivity reactions in patients.

1.5 SPECIAL HAZARDS AND PRECAUTIONS

1.5.1 Special Patient Conditions

A particularly careful benefit-risk evaluation must be carried out before the application of the H.E.L.P. apheresis in the case of patients suffering from C1 esterase inhibitor deficiency or hereditary C3 deficiency.

In the case of patients with low initial values of iron and fibrinogen, it is recommended that the subsequent course of the respective serum concentration be monitored.



Risk to patient due to thrombosis if the heparin is completely neutralised by protamin-chloride/ -sulphate.

- **These substances should only be administered to reverse the heparin effect in the case of life-threatening haemorrhaging.**



Risk to patient due to the elimination of parallel medication to differing extents. This means that the level of active substances in a patient who is receiving H.E.L.P. treatment can be lowered up to 60 %.

- **If possible, any regularly prescribed medication should be taken after the H.E.L.P. treatment.**

Please refer also to the product information provided with the consumables.

1.5.2 Electrical Hazards

The H.E.L.P. Plasmal® Futura machine contains life-threatening high electrical voltages.

 WARNING	<p>Risk of electric shock and fire.</p> <ul style="list-style-type: none"> ➤ Always insert mains plug completely into the mains socket. ➤ Always pull/push on the plug not on the mains cord to connect or disconnect the mains plug. ➤ Avoid damage of the mains cord for example by running over it with the machine. ➤ Complete disconnection from the electrical circuit results only if the mains plug is removed completely from the mains socket. No complete disconnection if the power switch is switched off!
--	--

Do not operate the machine and do not connect the machine to the power supply if the housing or the electrical cord is damaged in any way. A damaged H.E.L.P. Plasmal® Futura machine must be submitted for repairs or disposed.

1.5.3 Grounding Reliability

Grounding reliability can only be achieved when equipment is connected to an equivalent receptacle marked "hospital only" or "hospital-grade". North American medical equipment cords and plugs have to be "hospital-grade" or "hospital only", meaning, they are subject to special requirements contained in relevant applied standards. It is imperative that the ground connection be reliably maintained to protect the patient and medical staff. Hospital-grade power cords and cordsets carry the "green dot" signifying that they have been designed and tested for grounding reliability, assembly integrity, strength and durability.

1.6 INTERACTION WITH OTHER DEVICES

It is recommended that the machine be connected to a dedicated circuit. When using the H.E.L.P. Plasmal® Futura machine in combination with other therapeutic devices, it is recommended to use a connection line for electrical ground, since the leakage currents from all connected devices are additive.

1.6.1 Electromagnetic Interaction

The H.E.L.P. Plasmal® Futura machine has been developed and tested in accordance with the valid standards for interference suppression and electromagnetic compatibility (EMC). It cannot, however, be guaranteed that no electromagnetic interaction with other devices will occur.

Examples: mobile phones, computer tomograph (CT)

It is recommended that the use of mobile phones and other devices emitting strong electromagnetic radiation be restricted to a minimum distance from the H.E.L.P. Plasmal® Futura machine (refer to table in Chapter 9).

	<p>Operation of other therapeutic or diagnostic medical devices in conjunction with the H.E.L.P. Plasmal® Futura machine, or use of non medical devices directly near the H.E.L.P. Plasmal® Futura machine, should be carefully monitored.</p>
---	--

1.7 INFORMATION FOR THE OPERATOR

1.7.1 Training by the Manufacturer Prior to Commissioning

The operator may only use the device after the manufacturer has trained the responsible staff based on these instructions for use.

1.7.2 Requirements on the User



H.E.L.P. Plasmal® Futura machine may be operated only by skilled personnel who are duly trained and instructed on its use according to the contents of this instructions for use.

The operator must ensure that the instructions for use are read and understood by all operators of the H.E.L.P. Plasmal® Futura machine.

Prior to using the H.E.L.P. Plasmal® Futura machine, check its condition for safe functioning.

1.7.3 Conformity

The H.E.L.P. Plasmal® Futura machine complies with the current requirements of the following generally applicable standards:

- ANSI/AAMI/IEC 60601-1

Additional equipment connected to the analog or digital interfaces of the H.E.L.P. Plasmal® Futura machine must demonstrably meet the relevant IEC specifications (e.g. IEC 60950 for data processing devices and IEC 60601-1 for electromedical devices). Also, all configurations must conform with the current version of System Standard IEC 60601-1-1. Connecting additional devices to the signal input or output components of the H.E.L.P. Plasmal® Futura machine constitutes a system configuration. And the user is responsible for ensure compliance with the current version of System Standard IEC 60601-1-1. In case of queries, please contact your local specialist dealer or technical service.

Europe

In Europe, the H.E.L.P. Plasmal® Futura is a class IIb device complying with the essential requirements of EC-Directive 93/42/EEC for Medical Products which is indicated by the CE mark.

1.7.4 Manufacturer's Responsibility

The manufacturer, assembler, installer or implementer shall only be responsible for effects on the safety, reliability and performance of the device, if:

- the assembly, expansion, readjustments, changes or repairs were carried out by the manufacturer's, assembler's or installer's authorized representative.
- the area where the machine is installed complies with the current relevant national requirements on the equipment of medical treatment rooms:
(i. e. VDE 0100 part 710 and/or IEC stipulations).

The device may only be operated:

- if the manufacturer or an authorized person, acting on behalf of the manufacturer has carried out a functional check on site (initial commissioning),
- if the persons appointed by the operator to use the device have been trained in the correct handling, use and operation of the medical product with the aid of the Instructions for use, enclosed information and maintenance information.

1.7.5 Technical Changes

B. Braun Avitum AG reserves the right to change the products in line with further technical developments.

1.8 DISPOSAL

H.E.L.P. Plasmal® Futura machines may be returned to the manufacturer for disposal in accordance with the applicable disposal guidelines.

i

The company B. Braun Avitum AG guarantees the taking back of old B. Braun H.E.L.P. Plasmal® Futura machines.

The machine has to be disinfected according to regulations before disposal.

2	Product Description	3
2.1	PRINCIPLE	3
2.2	FUNCTION.....	4
2.3	MACHINE.....	6
2.3.1	Front View	6
2.3.2	Upper Module.....	7
2.3.3	Central Module	8
2.3.4	Control Buttons on the Central Module.....	9
2.3.5	Rear of the Machine.....	10
2.4	SYMBOLS ON THE H.E.L.P. PLASMAT [®] FUTURA MACHINE..	11
2.5	MONITOR.....	12
2.5.1	Monitor Controls	12
2.5.2	Keys for Operating the Blood Pump	13
2.5.3	Monitor Layout and Functions	13
2.6	CONSUMABLES.....	17
2.6.1	H.E.L.P. Futura Set	17
2.6.2	Solutions.....	18

2 Product Description

2.1 PRINCIPLE

H.E.L.P. Plasmate Futura is a plasma therapy unit that, together with the H.E.L.P. apheresis treatment unit, performs H.E.L.P. apheresis therapy. H.E.L.P. stands for Heparin-induced Extracorporeal LDL Precipitation.

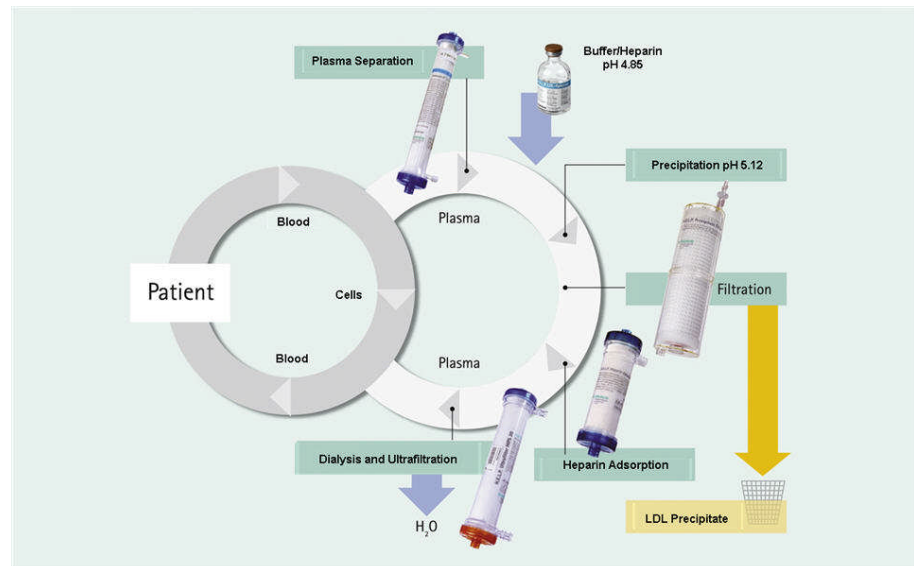

The first step of the procedure is plasma separation. The cellular blood components are directly reinfused to the patient along with the treated plasma. The plasma is mixed with a heparinized acetate buffer at a ratio of 1:1. LDL, fibrinogen and Lp(a), together with the heparin, form a precipitate in the acid pH range that is filtered out in the subsequent step. Excessive heparin is removed from the treated plasma using a heparin adsorber. In the last step, the plasma is adjusted to its initial volume and initial physiological pH value using bicarbonate dialysis and then reinfused into the patient along with the cellular blood components.

2.2 FUNCTION

The blood pump (BP) delivers the blood from the patient's venous access to the plasma filter. The blood flow is controlled via an arterial pressure transducer (PA). The heparin pump (HP) controls the heparin output for anticoagulation in the arterial line. The blood inlet pressure into the plasma filter is monitored via the prefilter pressure (PBE) of the arterial air chamber.

Blood that is separated in the plasma filter is returned via the venous line to the venous air chamber where it is mixed with the treated plasma which flows back via the reinfusion line. The reinfusion volume is equivalent to the volume of the separated plasma. The venous air chamber monitors blood reinfusion via a venous pressure transducer (PV). The venous line is monitored by a safety air detector (SAD) and closed by a safety air clamp (SAK) as soon as air is detected in the system.

The separated plasma is monitored after the plasma filter by a blood leak detector (BLD). Plasma flow is regulated via measurement of plasma pressure (PPL).

Plasma and heparinized acetate buffer are delivered via a plasma/buffer pump (PBP), in which a double pump segment is inserted, to the precipitate air chamber. Plasma and heparinized acetate buffer are mixed at a ratio of 1:1. The resulting precipitate is filtered in the subsequent precipitate filter. The precipitate filter pressure transducer (PPF) monitors the inlet pressure of the precipitate filter. The precipitate air chamber level valve and sensor control the fluid level in the precipitate air chamber.

The filtrate which is free from LDL is routed via the heparin adsorber air chamber to the heparin adsorber where the excessive heparin is removed. The heparin air chamber level valve and sensor control the fluid level in the heparin air chamber. The automatic clamp (HAK) in front of the heparin adsorber closes in case of a bypass during therapy.

In the dialyzer, the plasma is dialyzed with a sterile bicarbonate solution at a ratio of at least 1:2. The physiological pH-value of the plasma is restored and the induced volume removed by dialysis and ultrafiltration. The dialyzer pressure (PDF) monitors the inlet pressure of the dialyzer. The ultrafiltration rate, bicarbonate dialysate and buffer solution are balanced by the load cell (LC).

Dialysate is delivered via the dialysate pump (DP) and the ultrafiltration pump (UFP). The solution is heated in a plate warmer before flowing through the dialyzer. The dialysate air detector (DAD) detects air in the dialysate line. The pressure on the dialysate side is monitored via the inlet pressure of the dialysate (PDI).

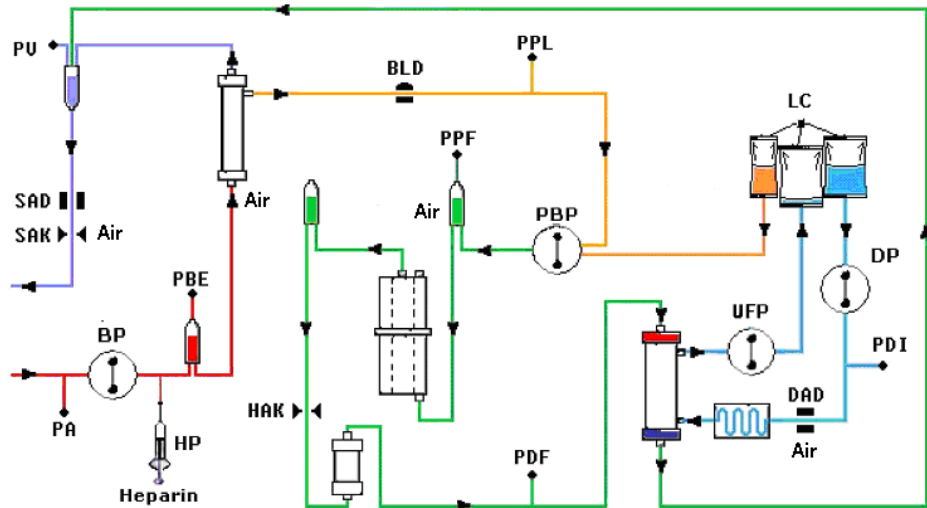

Pumps

- BP Blood pump
- HP Heparin pump
- PBP Plasma/buffer pump
- UFP Ultrafiltration pump
- DP Dialysate pump

Sensors

- PA Arterial pressure
- PBE Prefilter pressure
- PV Venous pressure
- PPL Plasma pressure
- PPF Precipitate filter pressure
- PDF Dialyzer pressure
- PDI Dialysate inlet pressure
- SAD Safety air detector
- BLD Blood leak detector
- DAD Dialysate air detector
- LC Load cell

Actuators

- SAK Safety air clamp
- HAK Heparin adsorber clamp

2.3 MACHINE

2.3.1 Front View

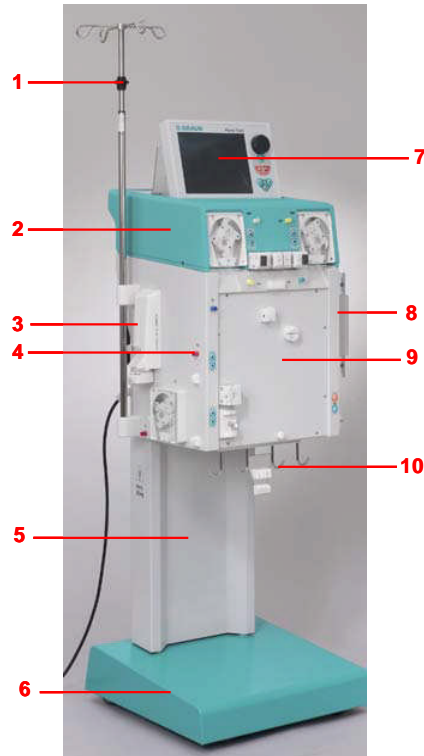

- 1) IV-pole (height-adjustable)
- 2) Upper module
- 3) Heparin syringe pump
- 4) Central module
- 5) Base column
- 6) Base with brake
- 7) LCD graphic monitor
- 8) Plate warmer
- 9) Front panel with attachment for the H.E.L.P. Futura kit
- 10) Bag holder/load cell

2.3.2 Upper Module

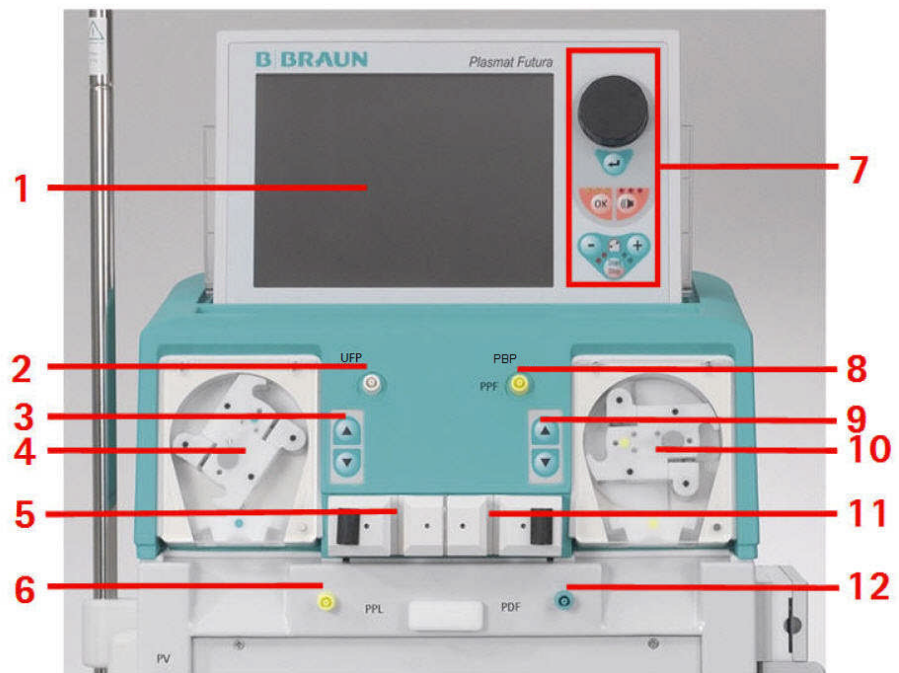

- 1) LCD graphic colour monitor
- 2) Connection to valve for automatic level setting in the heparin adsorber air chamber (HCLD)
- 3) Manual control for level setting in the heparin adsorber air chamber (HCLD)
- 4) Ultrafiltration pump (UFP)
- 5) Holder for heparin adsorber air chamber (HCLD) with sensor for level monitoring
- 6) Plasma pressure (PPL) transducer
- 7) Monitor controls
- 8) Precipitate filter pressure (PPF) transducer
- 9) Manual control for level setting of precipitate filter air chamber (PCLD)
- 10) Plasma/buffer pump (PBP)
- 11) Holder for precipitate filter air chamber (PCLD) with sensor for level monitoring
- 12) Dialyzer pressure (PDF) transducer

2.3.3 Central Module

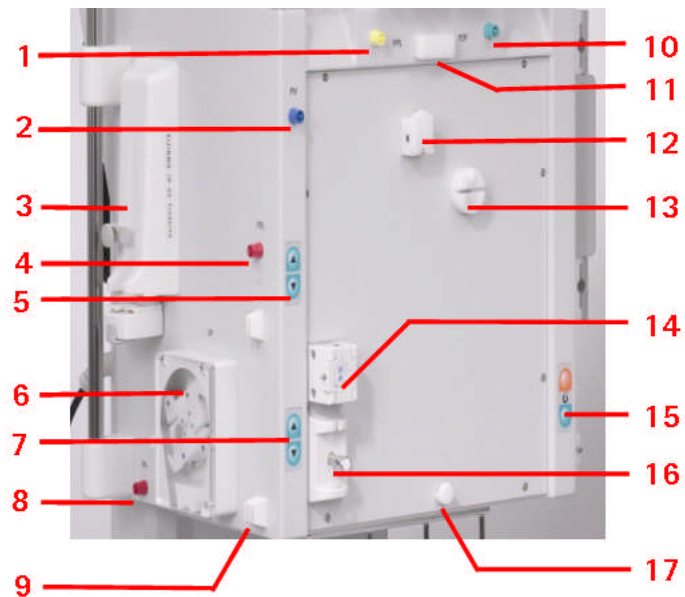

- 1) Plasma pressure (PPL) transducer
- 2) Venous pressure (PV) transducer
- 3) Heparin syringe pump (calibrated for 30 ml Omnifix®)
- 4) Prefilter pressure (PBE) transducer
- 5) Manual level regulator for venous air chamber
- 6) Blood pump
- 7) Manual level regulator for arterial air chamber
- 8) Arterial pressure (PA) transducer
- 9) Holder for arterial chamber
- 10) Dialyzer filter pressure (PDF) transducer
- 11) Upper holder for H.E.L.P. Futura kit
- 12) Blood leak detector (BLD)
- 13) Heparin adsorber clamp (HAK)
- 14) Venous safety air detector (SAD)
- 15) Brake pushbuttons for releasing/applying the brake
- 16) Safety air clamp (SAK)
- 17) Lower holder for H.E.L.P. Futura kit

Central module



- 1) Plate warmer
- 2) Dialysate pump (DP)
- 3) Brake pushbuttons (apply/release)
- 4) Dialysate inlet (PDI) pressure transducer
- 5) Dialysate (DAD) air detector

2.3.4 Control Buttons on the Central Module



The level adjustment in the respective chamber is performed with the directly adjacent level adjustment buttons. The ▲ button raises the level in the chamber, the ▼ button lowers the level.







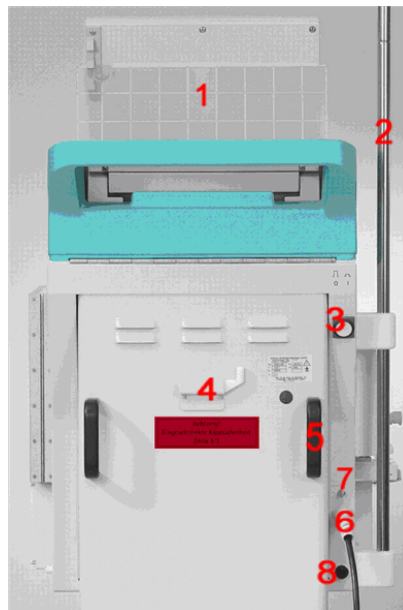

If the machine is switched on, with the red brake locking button, the brake can be applied. The brake can then be released with the green brake release button.

2.3.5 Rear of the Machine

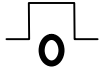
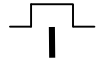

- 1) Monitor support
- 2) IV-pole
- 3) On/Off switch
- 4) Handcrank for pumps
- 5) Handles
- 6) Mains connection
- 7) Connection for potential equalization
- 8) Trend Viewer connector (optional)

2.4 SYMBOLS ON THE H.E.L.P. PLASMAT® FUTURA MACHINE

	Observe Instructions for use Observe safety information
	Application device type B Classification acc. to IEC 60601-1
	Electrical ground
	H.E.L.P. Plasmal® Futura OFF
	H.E.L.P. Plasmal® Futura ON
	Alternating current
	Schematic illustration on safety air detector (SAD) showing the correct way of installing the tube
	Trend Viewer connector (optional)

2.5 MONITOR

2.5.1 Monitor Controls

The rotary knob moves the cursor on the screen.

Display in lines:

- Clockwise rotation - the cursor moves from left to right
- Counterclockwise rotation - the cursor moves from right to left

Display in columns:



- Clockwise rotation - the cursor moves from top to bottom
- Counterclockwise rotation - the cursor moves from bottom to top

The set parameters are accepted by pressing .

With  important actions can be confirmed, such as

- Phase change (e.g. change from the priming/rinsing phase to the therapy phase).
- Quitting the <Parameter Setting> menu.
- Acknowledging messages that require immediate action (e.g. prompt for turning over the dialyzer during the priming and rinsing phase).

When this key is active, the yellow LEDs above it light. These LEDs blink during adjustment of parameters with relevance to patient safety.

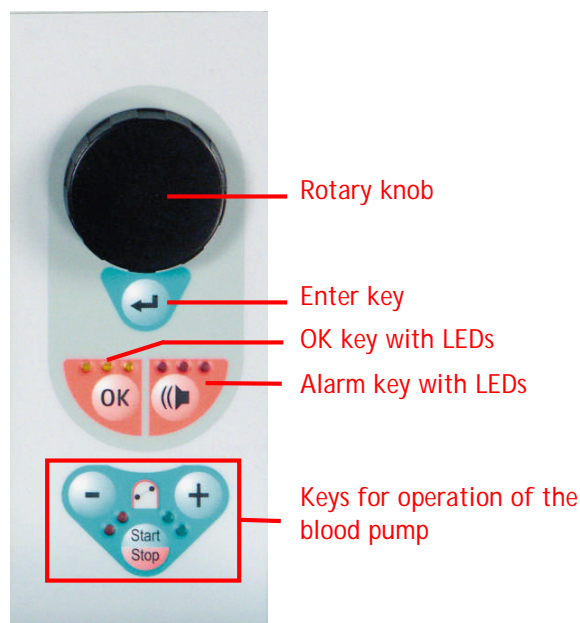

When an acoustic alarm occurs, switch off the alarm with . After elimination of the cause of the alarm, acknowledge the alarm with  and continue with the respective phase.

When this key is active, the red LEDs above it light.



Alarms initiated by opening a pump cover are reset by closing the pump cover.

2.5.2 Keys for Operating the Blood Pump

The  key and the  key lower or raise the delivery rate of the blood pump. If the blood pump stops during an alarm, the red LEDs light. If the blood pump runs, the green LEDs light. If both LEDs blink alternately, the blood pump has stopped and must be started manually with the  key. The running blood pump can also be stopped with this key.

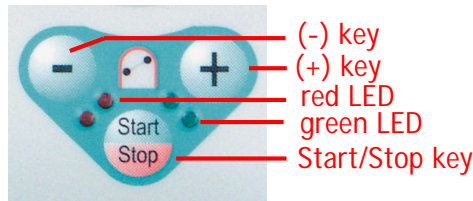

2.5.3 Monitor Layout and Functions

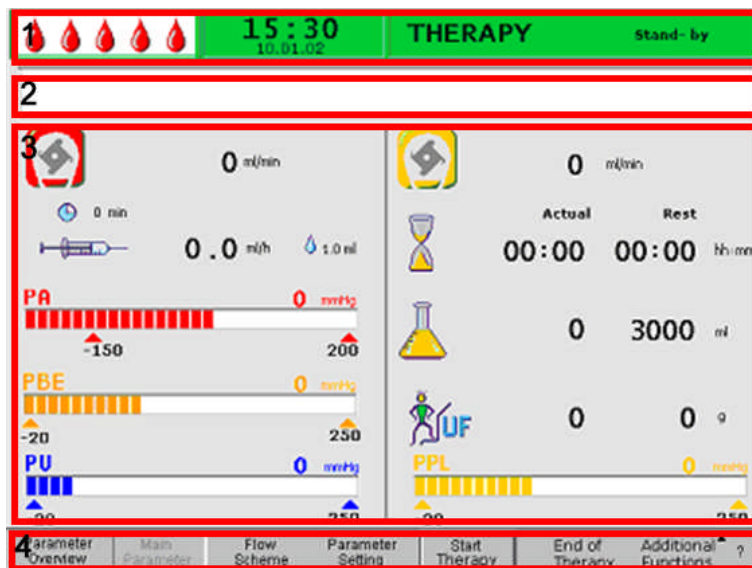

Status bar (1): The status bar indicates the activity of the blood pump, the current time and date, therapy phase (priming, therapy, reinfusion) and current status of the phase (stand by, running).

Alarm/Note line (2): This area of the monitor displays alarm texts and warning messages.

Display area (3): This area displays all parameters which are relevant in the current phase.

Menu bar (4): The menu bar displays the different menu items that can be selected depending on the treatment phase. Functions are selected with the rotary knob and activated with the  key.

Three display variants can be selected for the display area:

Main parameter

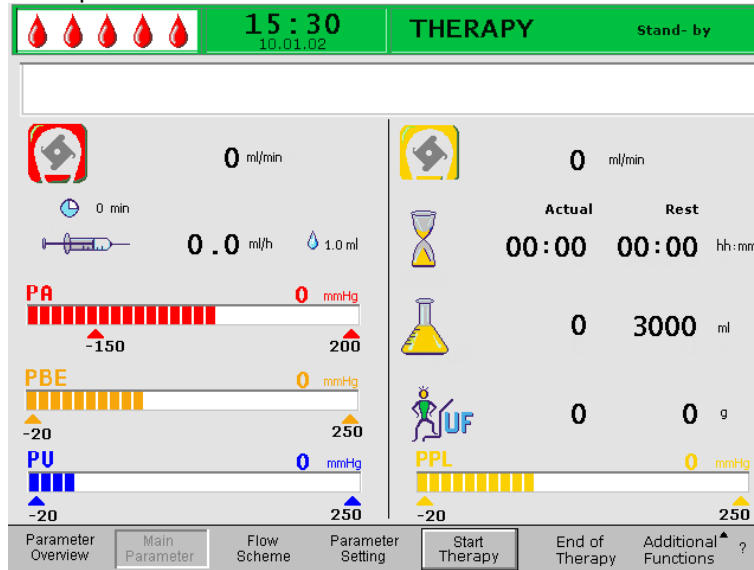

Parameter overview

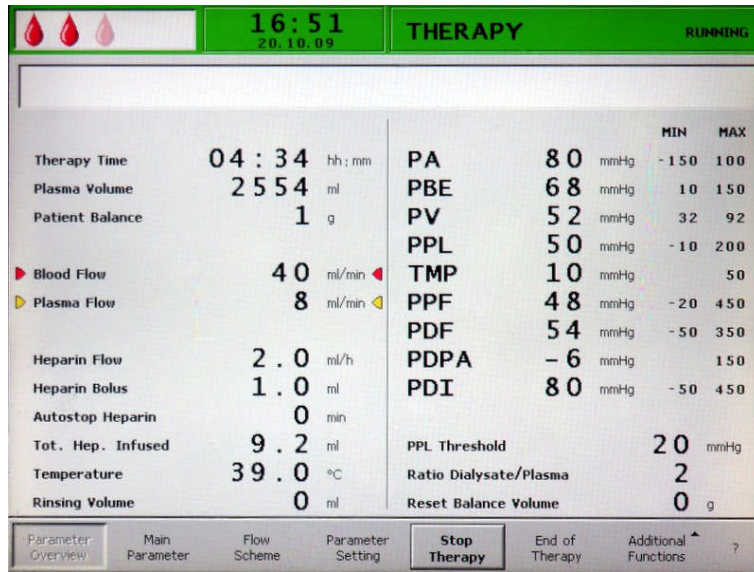

Flow scheme

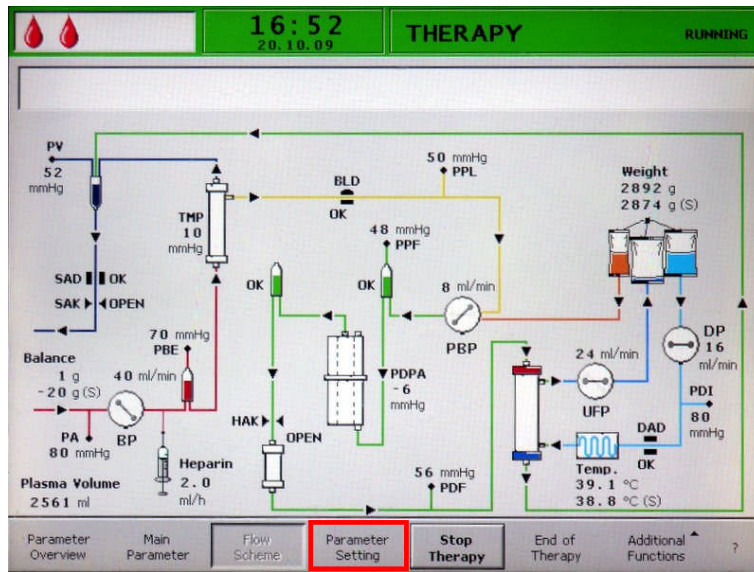

The Help screen can be selected from any screen with the ? key.

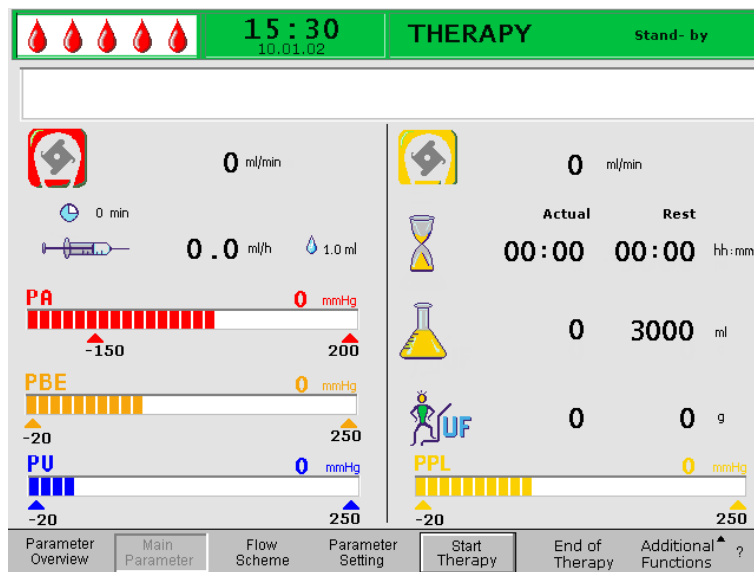

The symbols and abbreviations used for the different pressures in the display areas are explained on the Help screen.
To return to the previous screen select <Back Selection> or the screen returns automatically after 30 seconds.

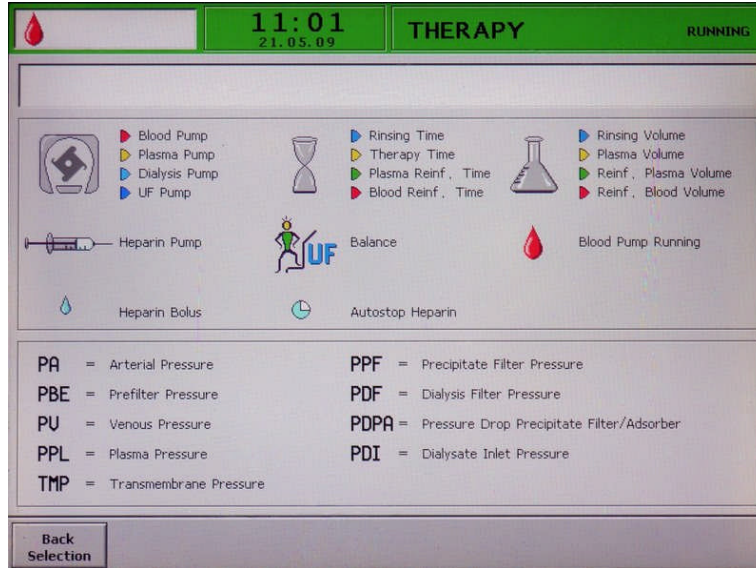

2.6 CONSUMABLES

The treatment unit for the H.E.L.P. Plasmal[®] Futura comprises the following:

2.6.1 H.E.L.P. Futura Set

The H.E.L.P. Futura set includes all line systems and filters required for performing H.E.L.P. treatment:

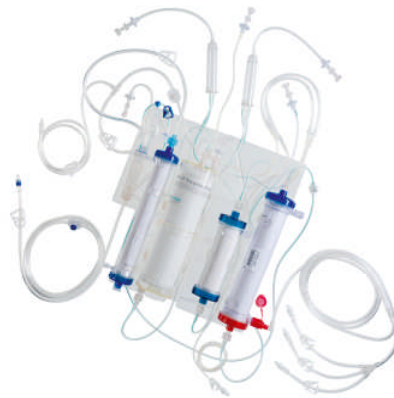

- H.E.L.P. Futura kit with

Haemoselect L 0.5 plasma filter
H.E.L.P. precipitate filter
H.E.L.P. heparin adsorber 400
H.E.L.P. ultrafilter HiPS 20



- Arterial line



- Dialysate line

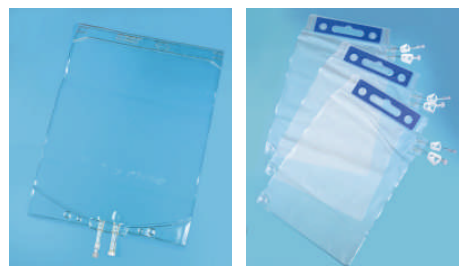

- 1 x 5 l empty bag for rinse solution
- 3 x 7 l drain bags

2.6.2 Solutions

The H.E.L.P. treatment unit includes, in addition to the H.E.L.P. Futura set, all solutions required for performance of a treatment:



- 2 x 3000 ml H.E.L.P. 0.9 % NaCl sodium chloride solution



- 1x 4000 ml H.E.L.P. sodium acetate buffer



- 1x 40 ml H.E.L.P. heparin sodium (400,000 IU)



- 2 x 5000 ml H.E.L.P. BicEl bicarbonate solution in a double-chamber bag



- 1 x 500 ml and 1 x 1500 ml H.E.L.P. 0.9 % NaCl sodium chloride in non-PVC bag

3	Preparation	3
3.1	SWITCHING ON AND SELFTEST	3
3.1.1	Switching on the Machine	3
3.2	PREPARING THE SOLUTIONS.....	3
3.3	SETTING UP THE BAGS.....	5
3.4	SETTING UP THE H.E.L.P. FUTURA SET.....	6

3 Preparation

3.1 SWITCHING ON AND SELFTEST

3.1.1 Switching on the Machine

Switch on the H.E.L.P. Plasmal® Futura with the On/Off switch on the rear of the machine. Make sure that the machine brake is locked during the treatment.

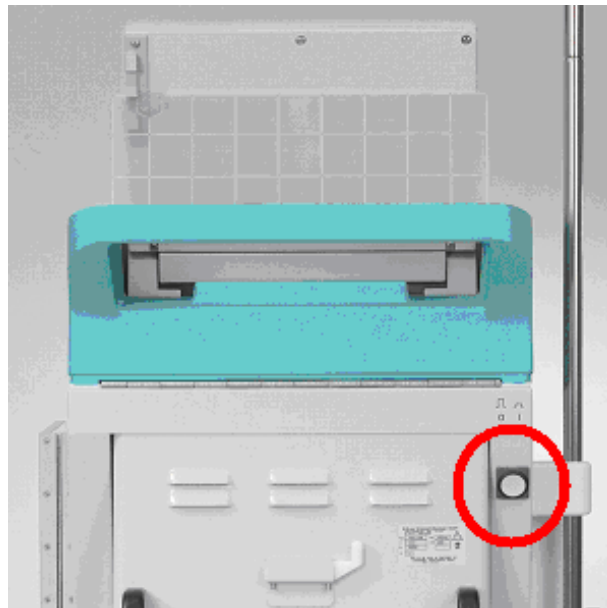

3.2 PREPARING THE SOLUTIONS



H.E.L.P. 0.9 % NaCl, physiological saline solution

- Remove the outer packaging of the saline bag.
- Fill a syringe with 1.5 ml heparin (5000 IU/ml).
- Remove the cannula from the syringe.
- Remove the screw cap from one of the Luer-lock connectors of the bag and insert the syringe.
- Break the seal of the bag.
- Inject the 1.5 ml heparin into the saline bag.
- Carefully mix the heparin with the saline solution.
- Prepare the second bag in the same manner.



Bicarbonate Solution H.E.L.P. BicEL

- Remove the outer packing from the bag.
- Place the bag on a firm base and press the smaller chamber of the bag with both hands until the seal seam between the two chambers is opened over its full length.
- Move the bag several times to and fro so that the two solutions are well mixed.
- Prepare the other bag accordingly.



If the ready-to-use BicEL solution is not used immediately after mixing, use of the solution within 24 hours is in the responsibility of the user.



Acetate Buffer Solution

- Remove the outer packaging of the acetate buffer bag.
- Fill a syringe with 40 ml H.E.L.P. heparin sodium solution for extracorporeal application.
- Remove the cannula from the syringe.
- Remove a Luer-lock connector from the acetate buffer bag and insert the syringe.
- Break the seal.
- Inject the 40 ml H.E.L.P. heparin sodium solution into the 4-I-acetate bag
- Carefully mix the H.E.L.P. heparin sodium solution with the acetate buffer.

3.3 SETTING UP THE BAGS



Physiological Saline Solution Bag/Empty Bag

- Hang the following on the IV-pole of the machine:
- one 5-l-empty bag with the connectors upturned,
 - one prepared 3-l-bag with physiological saline solution as well as
 - one 500 ml and one 1500 ml-bag with the physiological saline solution for reinfusion.



Physiological Saline Solution/Dialysate/Drain Bag

On the load cell hang:

- the second prepared 3-l-bag with physiological saline solution and
- two prepared bags with dialysate as well as
- after closing the large clamps hang on the drain bags.

i

Acetate buffer and dialysis fluid should have room temperature before priming. Cold solutions can impact pump function and may cause a failure of pressurization test. During treatment cold solutions may decrease the efficacy of the treatment.

3.4 SETTING UP THE H.E.L.P. FUTURA SET



WARNING

Risk to patient due to cross infection!

- Use disposables only once.

In case of hydrophobic filter breaks:

- Replace hydrophobic filter during therapy.
- Replace (or disinfect) internal pressure tubing/filter after therapy.

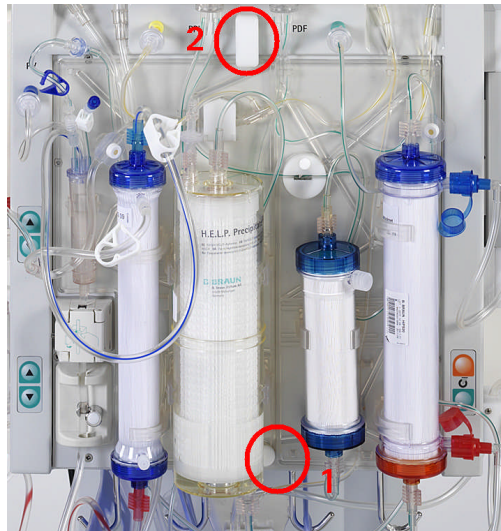

- 1 Place the plastic plate of the H.E.L.P. Futura kit on to the lower support on the machine. Press the plate against the front of the machine.
- 2 Secure the plate with the upper rotary attachment knob.

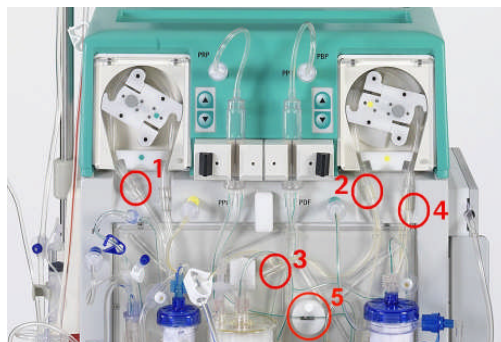

- 1 Place the pump segment of the ultrafiltration line into the ultrafiltration pump (white marking on the left).
- 2 Place the pump segments of the plasma/buffer line successively into the plasma/buffer pump (marked brown and yellow).
- 3 Place the plasma line coming from the plasma filter into the blood leak detector BLD.
- 4 Check whether the pump segments are inserted in the correct orientation.
- 5 Firmly insert the filtrate line to the heparin adsorber into the heparin adsorber clamp (HAK).



- 1 Place the two air chambers into the holders as shown. Lock them in place in the holder by turning the black lock.
- 2 Screw on the four pressure transducers as shown.
- 3 Check that the venous air chamber is placed in the holder and screw on the venous pressure transducer.



- 1 Place the venous line into the safety air detector SAD
- 2 and into the safety air clamp SAK.
- 3 Connect the venous line to the 5-l-empty bag which is hanging on the IV-pole.



- 1 Connect the buffer line to the prepared saline bag on the load cell.
- 2 Connect the ultrafiltrate lines to the three drain bags.
- 3 Insert the buffer line into the holder provided on the load cell.

Setting up the arterial line

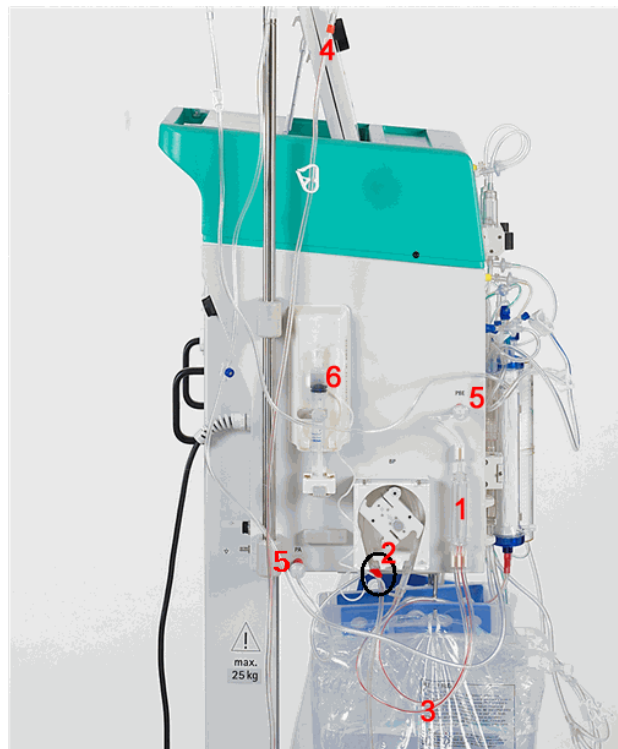

- 1 Place the arterial air chamber into the holder.
- 2 Place the pump segment of the arterial line with the red marking on the left side into the blood pump.
- 3 Connect the arterial feeder line to the inlet of the plasma filter.
- 4 Connect the arterial line to the prepared saline bag which is hanging on the IV-pole.
- 5 Screw on the two pressure transducers as shown in the figure.
- 6 Fill a syringe (30 ml Omnifix® Perfusor syringe) with heparin saline mixture and connect it with the heparin line. Vent the heparin line manually up to the T-piece. Make sure that no air bubbles are left in the line. Mount the syringe on the holder of the heparin pump.

Recommendation: 16 ml 0.9% NaCl + 4 ml heparin (5000 IU/ml) corresponding to a concentration of 1000 IU heparin/ml.

Setting up the dialysate line



- 1 Insert the heating bag into the plate warmer.
- 2 Connect the blue inflow line to the dialyzer. Make sure that the Hansen connector is firmly seated.
Note: Connect red with red and blue with blue!
- 3 Place the blue inflow line into the dialysate air detector (DAD).
- 4 Insert the pump segment of the dialysate line with the blue marking on the left side into the dialysate pump.
- 5 Screw on the pressure transducer.
- 6 Connect the prepared dialysate bag to the distributor of the dialysate line and break the seal.
- 7 Insert the dialysate inlet line into the provided holder of the load cell.

4	Priming and Rinsing	3
4.1	AUTOMATIC PRIMING AND RINSING	3
4.2	PARAMETER SETTING	10
4.2.1	Parameter Setting in the <Main Parameter> Screen	10
4.2.2	Parameter Setting in the <Parameter Overview> Screen	14
4.2.3	Parameter Setting in the <Flow Scheme> Screen	18
4.2.4	Additional Functions	19

4 Priming and Rinsing

4.1 AUTOMATIC PRIMING AND RINSING

On the Start screen, the following message is displayed blinking and in red:

Press Enter key to start!

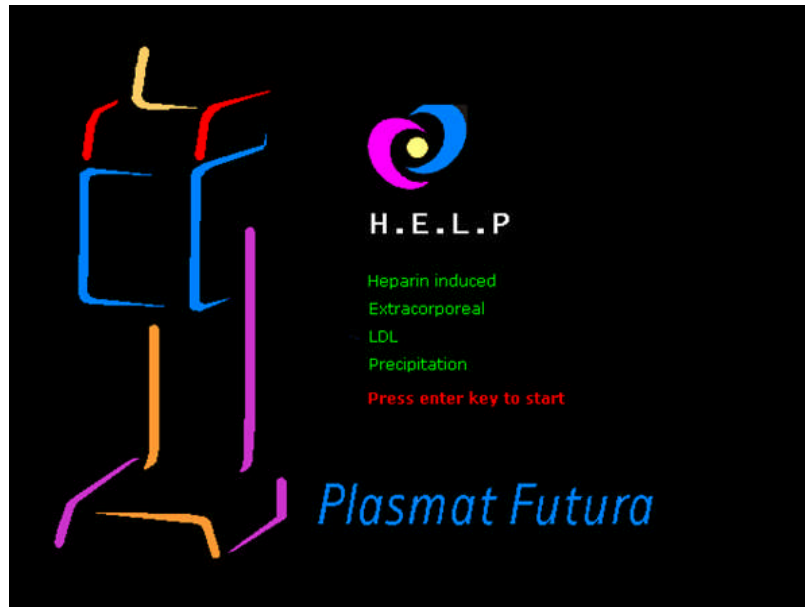

- If the machine has been prepared as described in the previous chapter, press the  key to begin priming and rinsing the system.

Status bar

- 1) Display of blood pump activity
 - a) Blood pump stands still: One still, four blinking drops.
 - b) Blood pump runs: Increasing and decreasing number of drops.
- 2) Current time and date
- 3) Current phase (<Priming>) and current step in the priming phase (<Stand-by [00]>)

Menu bar

- 4) The Main Parameter screen is displayed by default. The active screen display is indicated by the display of the recessed <Main Parameter> menu item in the menu bar.
- 5) In the menu bar, the cursor is already positioned on <Start Priming>. The label changes between black and gray (blinking). This shows that an input is expected from the user.

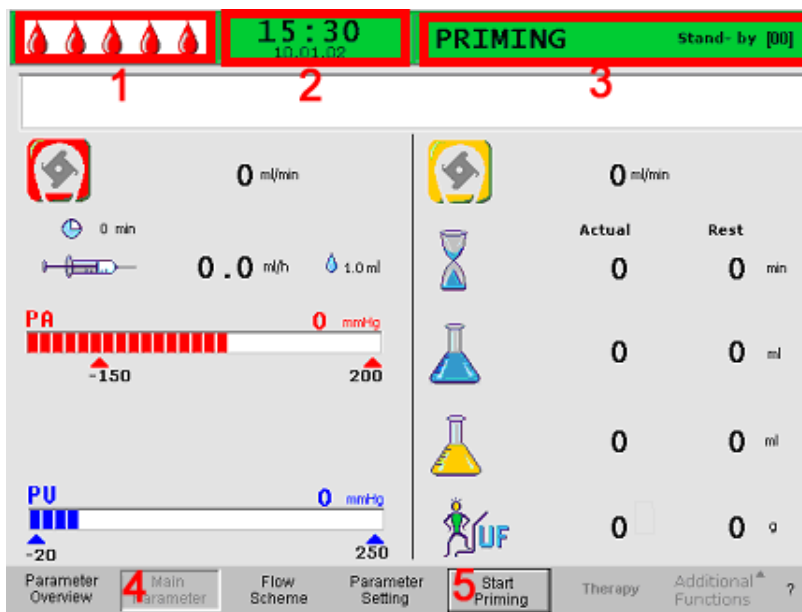

Display area

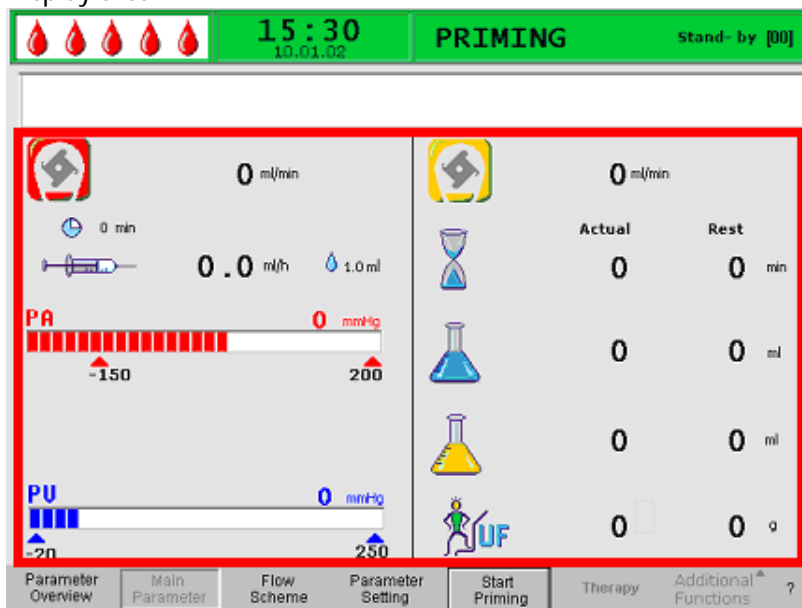



Blood flow in ml/min



Heparin flow in ml/h



Heparin bolus in ml

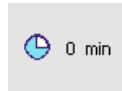

Autostop heparin in min



Plasma flow in ml/min



Rinsing time [Actual/Rest] in min



Rinsing volume [Actual/Rest] in ml



Plasma volume [Actual/Rest] in ml



Balance in g



Arterial pressure in mmHg



Venous pressure in mmHg

When <Parameter Overview> is selected in the menu bar, the screen display changes to Parameter Overview.

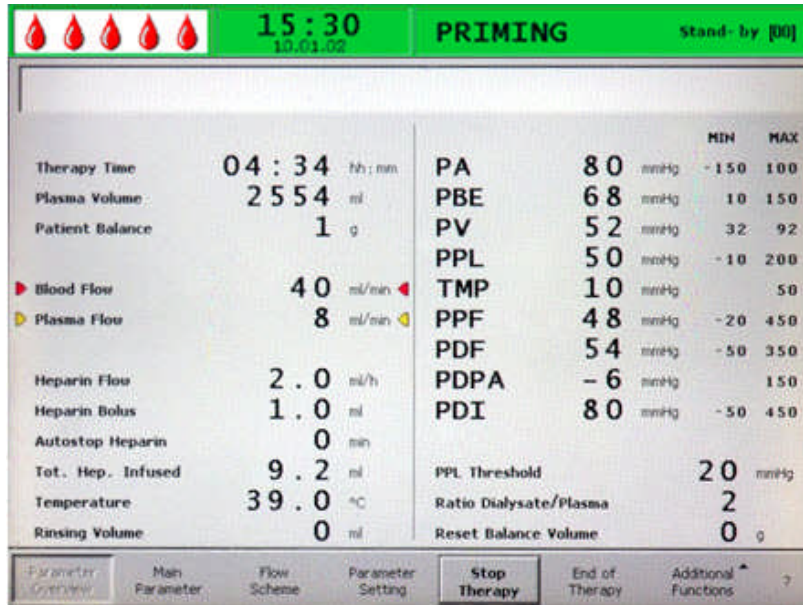

By selecting the <Flow Scheme> menu item in the menu bar, the display changes to the Flow Scheme.

When in the <Flow Scheme> screen the <Parameter Setting> menu item is selected in the menu bar, the screen changes to the Parameter Overview.

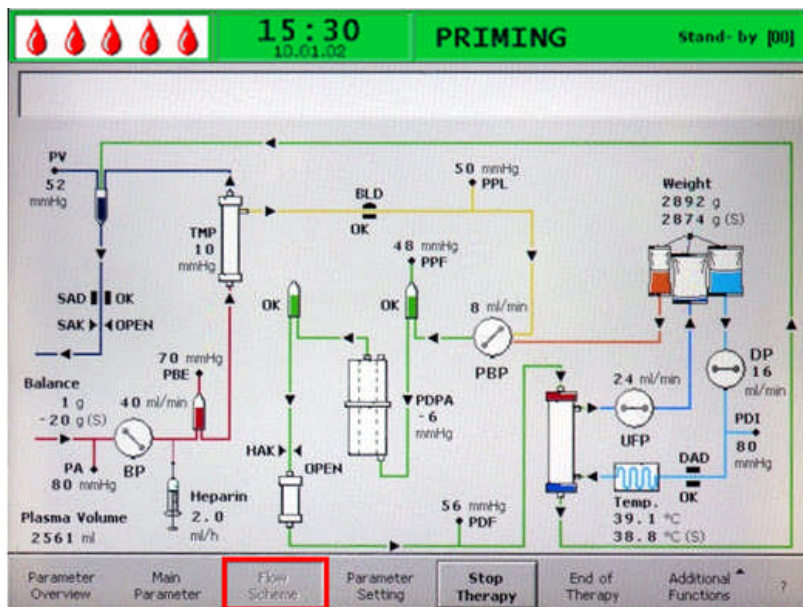

Final System Check

- Ensure that all connections between the line system and the filters have been made.
- Tighten all screw locks as well as the Hansen connectors again.
- Make sure that the lines are not kinked.
- Make sure that the electrolyte solution is mixed with the bicarbonate solution and the sealing seam is completely open.
- Make sure that the break seals of the saline bags on the IV-pole and the load cell are open.
- Make sure that the break seals of the dialysis fluid bags are open.
- Ensure that the clamps at the unused ports of the empty bags are closed.

The prompt <W18: Break seals and open all clamps!> appears in the Warning window.

- Press **OK** to continue.
- The <Start Priming> command in the menu bar blinks (the label changes between black and grey). This shows that an input is expected from the user.



After starting priming by selecting <Start Priming>, the message <W01: Plasma pump starts after pressurization blood side> is displayed in the message line.

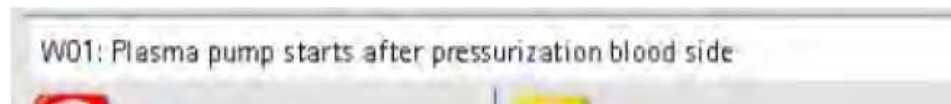

Automatic Filling of Blood Side

During automatic filling, the arterial line, the plasma filter and the venous line are rinsed and filled by default with 600 ml saline solution.

- Start filling the arterial line by pressing the  key.

Step 1/2

The arterial line, the plasma filter and the venous line are filling. The preset blood flow rate is 150 ml/min.

Step 3

The safety air clamp (SAK) opens and then closes again and the level of the arterial chamber is set accordingly. This vents the plasma filter.

Step 4

The plasma/buffer pump starts and the precipitate filter is filled. This step is completed when the level monitoring of the precipitate filter air chamber (PCLD) detects fluid and the balance test 1 has been completed.

Step 5

Filling the heparin adsorber air chamber (HCLD).

Step 6

Leakage test of the heparin adsorber clamp.

Step 7

The heparin adsorber clamp (HAK) opens. The level detection in the heparin adsorber air chamber and the venting of the connection line to the heparin adsorber are performed. This step includes the filling of the dialyzer on the plasma side.

Step 8

The Warning window prompts with <W04: Turn dialyser (blue side down) !>. Turn the dialyzer by 180°, with the blue side pointing downward.

- Press  to continue.

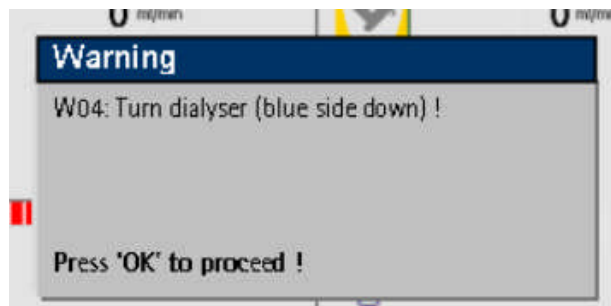

Step 9

The dialysate side filling of the dialyzer is performed during this step. The balance test 2, the DAD test, the heating test, the venous pressure test as well as the reinfusion pump test are performed in this step.

Step 10

The setting of the level of the venous air chamber is performed.

Step 11

This step is completed when the minimum rinsing volume of 2400 ml is reached. The following message is displayed in the Warning window <W14: Rinsing completed. For further rinsing set new value ! >.

- Press  to confirm the reaching of the minimum rinsing volume.
- If the minimum rinsing volume is sufficient, you can now start with the therapy.

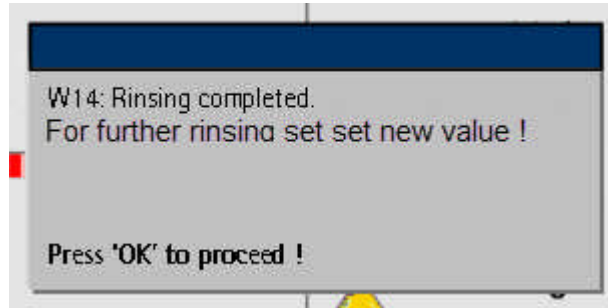
**Step 12****Optional rinsing**

This step allows rinsing of the system beyond the minimum rinsing volume.

If you wish to increase the rinsing volume:

- Select the <Parameter Setting> command in the menu bar.
- Select the <Rinsing volume> parameter and change this parameter. The rinsing volume can be set to a value of up to 10 l.
- Then select the <Start Priming> command in the menu bar. When the rinsing volume has been reached, all pumps stop automatically.



For more details on increasing the rinsing volume, see also the Chapters 4.2.1 and 4.2.2.



When increasing the rinsing volume over 2400 ml, make sure that sufficient saline solution is available. If required, change the bags on the load cell and on the IV-pole.

Additional Manual Rinsing of Blood Side

If you wish to increase the rinsing volume in the blood circuit:

- Start the blood pump with .
- When sufficiently rinsed the blood side, press again  to finish rinsing.



When increasing the rinsing volume, make sure that sufficient saline solution is available. If required, change the bags on the IV-pole.



Make sure after rinsing that all air is removed before connecting to the patient to avoid air infusion.

4.2 PARAMETER SETTING

4.2.1 Parameter Setting in the <Main Parameter> Screen

- To set the parameters, select the <Parameter Setting> menu item with the cursor in the <Main Parameter> screen and activate it with the  key.

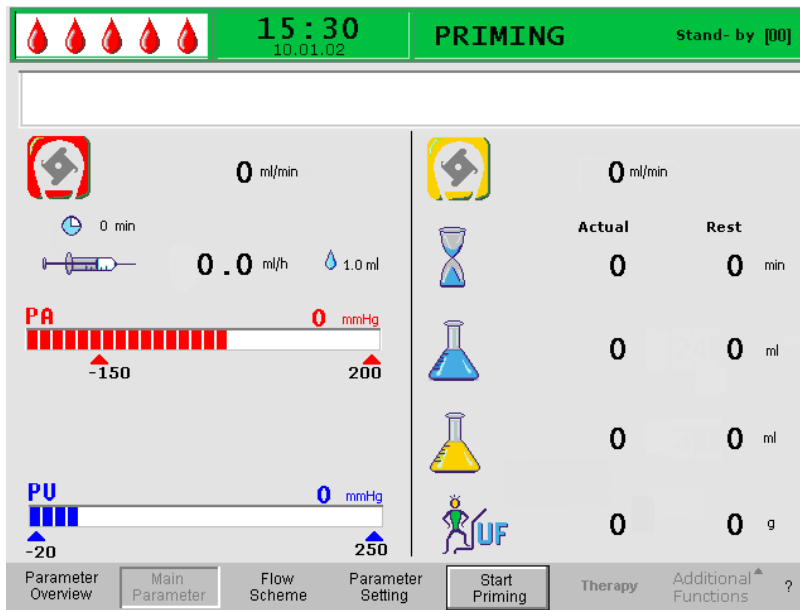

All parameters which can be changed are displayed in red. The currently selected parameter has a grey background. The range which can be selected is displayed in the Setting window. Using the rotary knob, you can select the individual parameters.

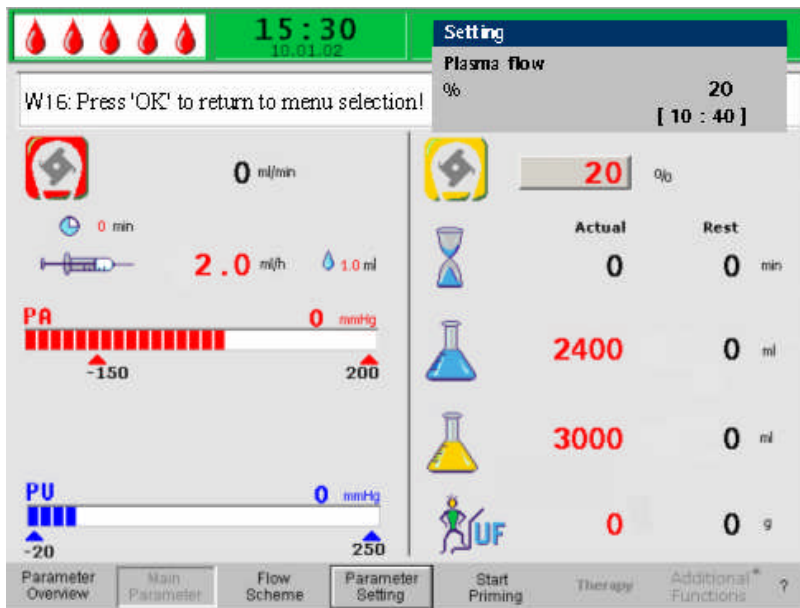

The following parameters can be set in the priming and rinsing phase:



Plasma flow rate (%)



Rinsing volume (ml)



Plasma volume (ml)



Balance (g)



Heparin flow rate (ml/h)



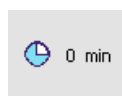

Heparin bolus (ml)

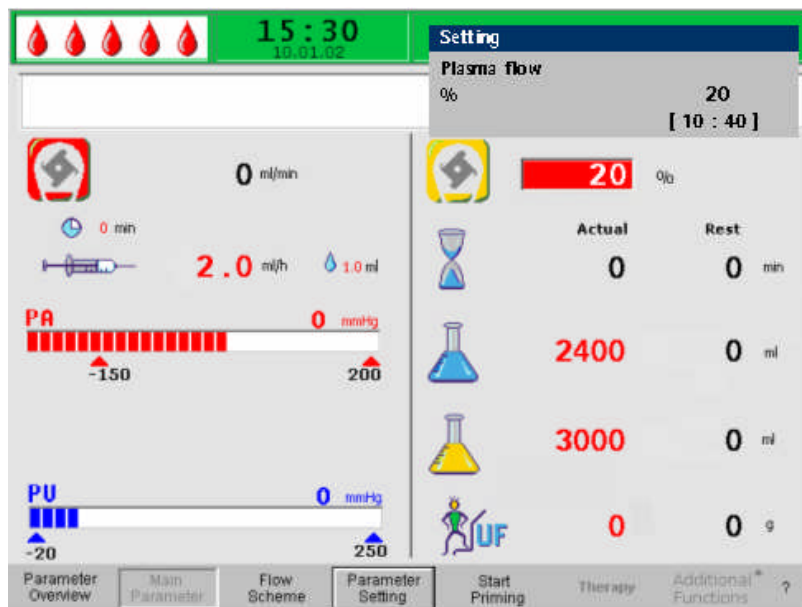

Autostop heparin (min)

- Press the  key to select the parameter to be changed. The field is shown with a red background and white labeling.



- Perform the desired change using the rotary knob and confirm it with the  key.

The changing of the following parameters must be confirmed with the  key since they are relevant to patient safety:

- Plasma flow rate
- Plasma volume
- Balance
- Heparin bolus
- Heparin flow rate

If a parameter is relevant to patient safety, the currently set value is shown in the Setting window above the setting range. In addition, the LEDs above the  key blink.

➤ To quit the screen for setting the parameters, press the  key. The cursor changes back to the menu bar of the Main Parameter screen and the menu item <Start Priming>.

If you do not perform any settings for more than 15 seconds, the screen automatically changes back to the previously selected screen.

The following parameters can be set in the priming and rinsing phase:

	Default setting	Range	Step size
Plasma flow	20 % of blood flow	10 - 40 % of blood flow	1 % of blood flow
Rinsing volume*	2400 ml	2400 – 10000 ml	100 ml
Plasma volume	3000 ml	100 - 6000 ml	50 ml
Patient balance	0 g	-600 g – 0 g	50 g
Heparin bolus	1 ml	0 – 10 ml	0.5 ml
Heparin flow	2 ml/h	0 – 10 ml/h	0.5 ml/h
Autostop heparin	0 min.	0 – 60 min.	5 min.

*The rinsing volume can be increased beyond the set minimum rinsing volume of 2400 ml.



The plasma flow is limited to a maximum of 40 % of the blood flow, and 50 ml/min. If the blood flow is changed manually, the plasma flow is automatically changed according to the set ratio. The plasma flow is set in % of blood flow, and is displayed in ml/min.



With a plasma volume > 4000 ml, it must be taken into account that the acetate buffer bag and the dialysate bags must be changed.



WARNING

With a plasma volume > 4000 ml the heparin adsorber must be changed in order to keep the required capacity.



This is not an ultrafiltration within the context of a dialysis. This option provides the possibility of additionally removing the existing physiological saline solution or to balance the physiological saline solution required for blood reinfusion. When setting a balance, it must be observed that this changes the haematocrit value of the blood and could make the separation of plasma sometimes more difficult.



CAUTION

Risk to the patient due to hypotension in rare cases.
➤ Change the therapy as prescribed by the supervising physician.



Risk to patient due to insufficient or too high heparinization.

- Use only 30 ml Omnifix® Luer Lock syringes from B. Braun Melsungen AG. Calibration of the heparin syringe pump is ensured only with use of the Omnifix® Luer Lock syringe.



Autostop heparin indicates how long before the end of the therapy the heparin administration is stopped. If the therapy time is increased after the heparin pump is switched off, the heparin pump starts again automatically.

4.2.2 Parameter Setting in the <Parameter Overview> Screen

➤ Using the rotary knob and the  key, change to the <Parameter Overview> screen.

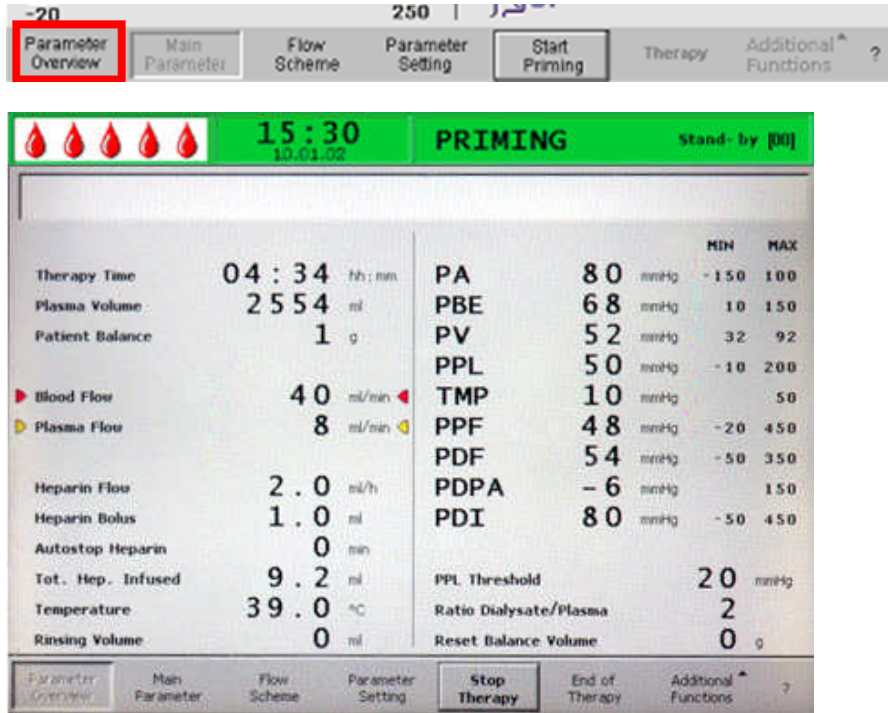

➤ To set the parameters, select the <Parameter Setting> menu item with the cursor in the <Parameter Overview> screen and activate it with .



For a better overview, blood flow (red) and plasma flow (yellow) are marked with colored arrows in the Parameter Overview.



All parameters which can be changed are displayed in red. The currently selected parameter has a gray background. The Setting window displays the allowable range. Using the rotary knob, select the individual parameters.

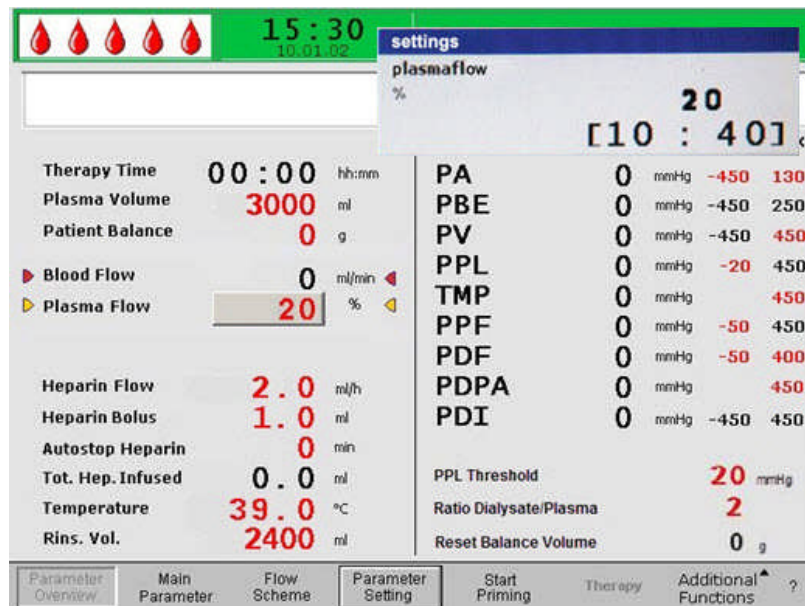



The following parameters can be set in the priming and rinsing phase:

- Plasma volume (ml)
- Balance (g)
- Plasma flow in %
- Heparin flow (ml/h)
- Heparin bolus (ml)
- Autostop heparin (min)
- Temperature (°C)
- Rinsing volume (ml)
- PA min (mmHg)
- PA max (mmHg)
- PV MIN window (mmHg)
- PV MAX window (mmHg)
- PPL min (mmHg)
- TMP max (mmHg)
- PPF min (mmHg)
- PDF min (mmHg)
- PDF max (mmHg)
- PDPA max (mmHg)
- PPL Threshold (mmHg)
- Ratio Dialysate/Plasma

- Press the  key to activate the parameter to be changed. The field is shown with a red background and white labeling.



- Perform the desired change using the rotary knob and confirm it with the  key. The changing of the following parameters must be confirmed with the  key since they are relevant for safety:

- Plasma flow rate
- Plasma volume
- Balance
- Heparin flow rate
- Heparin bolus
- PV MIN window (mmHg)
- PV MAX window (mmHg)
- PA MIN (mmHg)
- PA MAX (mmHg)
- Ratio Dialysate/Plasma

If a parameter is relevant for safety, the currently set value is shown in the Setting window above the setting range. In addition, the LEDs above the  key blink.



Risk to patient due to blood loss since increasing the PV MIN window elevates the likelihood of an unrecognized removal of the venous access.

- Do not cover the venous access.
- Keep the patient under continuous surveillance.

- To quit the screen for setting the parameters, press the  key. The cursor changes back to the menu bar of the Parameter Overview screen and the menu item <Start Priming>.

If you do not perform any settings for more than 15 seconds, the screen automatically changes back to the previously set screen.

In addition to the parameters listed in chapter 4.2.1., the following parameters can be entered:

	Default setting	Range	Step size
Temperature	39 °C	34 – 40 °C	0.5 °C
PA min	-150 mmHg	-350 – 80 mmHg	10 mmHg
PA max	100 mmHg	0 – 200 mmHg	10 mmHg
PV window min	20 mmHg	10 – 40 mmHg	5 mmHg
PV window max	40 mmHg	20 – 100 mmHg	5 mmHg
PPL min	-10 mmHg	-20 – 10 mmHg	1 mmHg
TMP max	70 mmHg	20 – 200 mmHg	10 mmHg
PPF min	-20 mmHg	-50 – 50 mmHg	5 mmHg
PDF min	-50 mmHg	-50 – 0 mmHg	5 mmHg
PDF max	350 mmHg	10 – 400 mmHg	10 mmHg
PDPA max	150 mmHg	50 – 350 mmHg	10 mmHg
PPL Threshold	20 mmHg	-10 – 120 mmHg	5 mmHg
Ratio dialysate/plasma	2	1 - 4	1

4.2.3 Parameter Setting in the <Flow Scheme> Screen

➤ Using the rotary knob and the  key, change to the <Flow Scheme> screen.

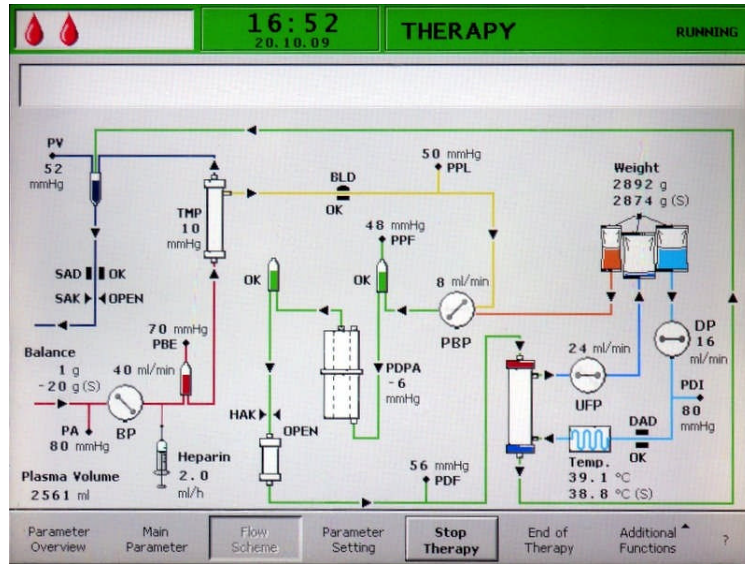
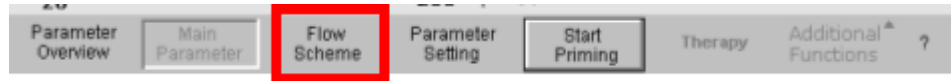

➤ To set the parameters, select the <Parameter Setting> menu item with the cursor in the <Flow Scheme> screen and activate it with the  key.



The screen changes to the setting screen of the Parameter Overview and you can perform here all settings as described in chapter 4.2.2.

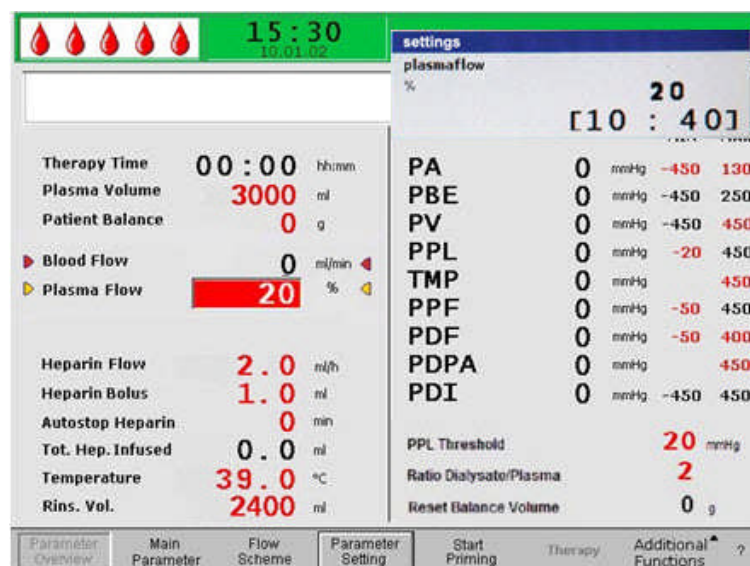

4.2.4 Additional Functions

During Priming and Rinsing in the <Main Parameter>, <Parameter Overview>, and <Flow Scheme> screens, the <Additional Functions> menu item is not active.



New Therapy:

To cancel the priming and rinsing phase and return to the Start screen, switch off the machine and switch it on again while pressing .

5	Therapy	3
5.1	STARTING THE THERAPY	3
5.1.1	Starting the Blood Circuit	6
5.1.2	Starting the Plasma Circuit	6
5.2	TERMINATING THERAPY	7
5.3	PARAMETER SETTING	9
5.3.1	Parameter Setting in the <Main Parameter> Screen	9
5.3.2	Parameter Setting in the <Parameter Overview> Screen	11
5.3.3	Parameter Setting in the <Flow Scheme> Screen	14
5.4	ADDITIONAL FUNCTIONS	15
5.4.1	Premature Termination of Therapy	15
5.4.2	Premature Termination of Therapy by Power Failure	16
5.4.3	Additional Functions	17
5.4.4	Heparin Bolus	19

5 Therapy



Risk to patient due to leakage of acetate buffer bag.

- Loss of acetate buffer to the environment leads to a lower efficacy of the therapy.
- Loss of acetate buffer to the environment may cause a wrong ultrafiltration.
- Acetate buffer in the environment can harm user and patient, mainly if mixed with disinfection fluids such as hypochlorite. Gas formation! Open the window and evacuate the room.

5.1 STARTING THE THERAPY

- After the completion of the priming and rinsing phase, select the <Therapy> menu item in the menu bar and confirm with .

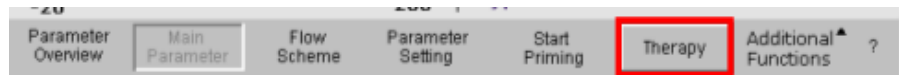

The following message is displayed in the warning window <W32: Activate therapy mode ?>

- Confirm the message with the  key.

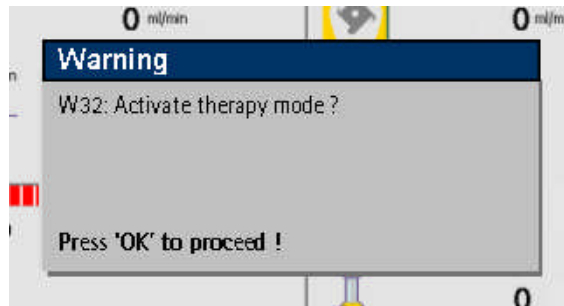

The change to the therapy phase is possible only when the minimum rinsing volume of 2400 ml has been reached.

The screen changes to the Therapy screen:

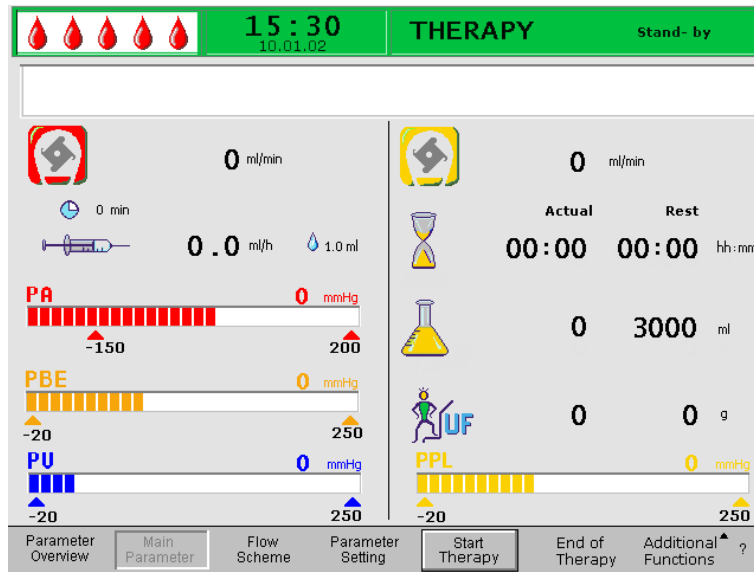

Display Area of Therapy Screen:



Blood flow in ml/min



Heparin flow in ml/h



Heparin bolus in ml

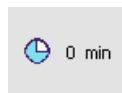

Autostop heparin in min



Plasma flow in ml/min



Therapy time [actual/rest] hh:mm



Plasma volume [actual/rest] in ml



Balance in g

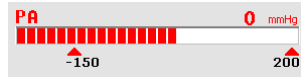

Arterial pressure in mmHg

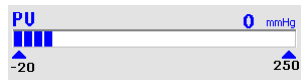

Venous pressure in mmHg

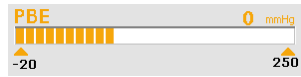

Prefilter pressure in mmHg

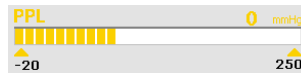



Plasma pressure in mmHg.

➤ Select <Start Therapy> in the menu bar.

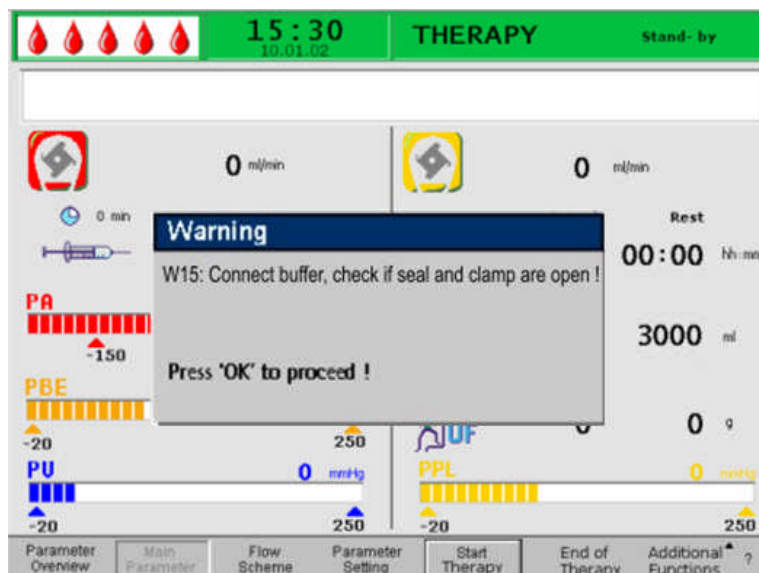

The following message is displayed in the warning window: <W15: Connect buffer, check if seal and clamp are open!>.







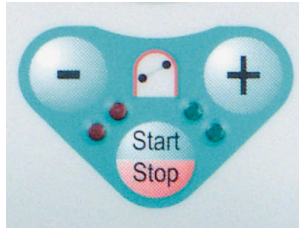

- Exchange the saline bag on the load cell with the prepared acetate buffer bag.
- Remove the venous line from the empty bag on the IV-pole and screw it to the second connection of the saline bag on the IV-pole (next to the arterial line).
- Remove the empty bag from the IV-pole.
- Remove the clamps from the bag and the buffer line and make sure that all bag break seals are open.
- At this point at the latest, enter the parameters required for the therapy, such as plasma volume, heparin flow, heparin bolus, etc. (see chapter 4.2).
- Confirm the message in the warning window with .

The machine is now ready for the therapy and can be connected to the patient.

5.1.1 Starting the Blood Circuit



- Disconnect the arterial line from the physiological saline bag on the IV-pole.
- Connect the line to the patient access for drawing blood.
- The green and red LEDs above the  key blink alternately. Start the blood pump with the  key. The default setting of the blood flow is 40 ml/min.
- If desired, adapt the blood flow with the  key or the  key to the existing pressure situation.
- When the first traces of blood reach the saline bag on the IV-pole, stop the blood pump with the  key.
- Connect the venous line to the patient access for blood return.
- Start the blood pump with  and adapt the blood flow to the existing pressure conditions and the tolerance of the patient. Observe the pressure limits which are displayed on the monitor!

i

The patient can also be connected venovenous without phlebotomy but with volume substitution. Connect the patient's arterial line as well as the venous line to the patient's accesses for drawing blood and blood return, respectively. Fill the blood-side line system by pressing the  key.

5.1.2 Starting the Plasma Circuit

- Allow the blood to circulate for a short period (approx. two minutes) until a spontaneous yellow coloring occurs in the proximal part of the plasma filter.
- Start the therapy by selecting the <Start Therapy> menu item:

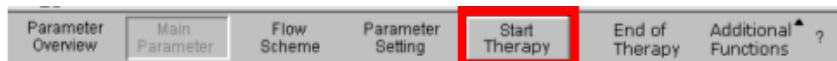

- Confirm by pressing . Plasma treatment begins. The softkey text <Start Therapy> changes into <Stop Therapy>.

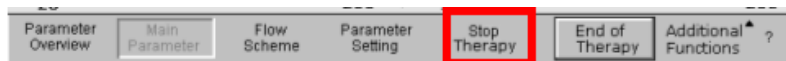

The treatment is automatically monitored and terminated when the desired plasma volume has been reached. The treatment can be interrupted at any time with the <Stop Therapy> menu item and switching to the reinfusion phase.



The therapy period is timed only while the plasma circuit is running.



Risk to patient due to hemolysis because of a high shear stress.

- Gradually increase first the blood flow rate to reach the desired target value after 5 minutes.
- Only start therapy as soon as enough plasma has been separated in the plasma filter on the plasma side.
- Afterwards increase the plasma flow step by step until a suitable value has been reached.

5.2 TERMINATING THERAPY

When the treated plasma volume is achieved, the machine switches to the stand-by mode. The blood circuit continues to circulate with the most recent blood flow rate selected.

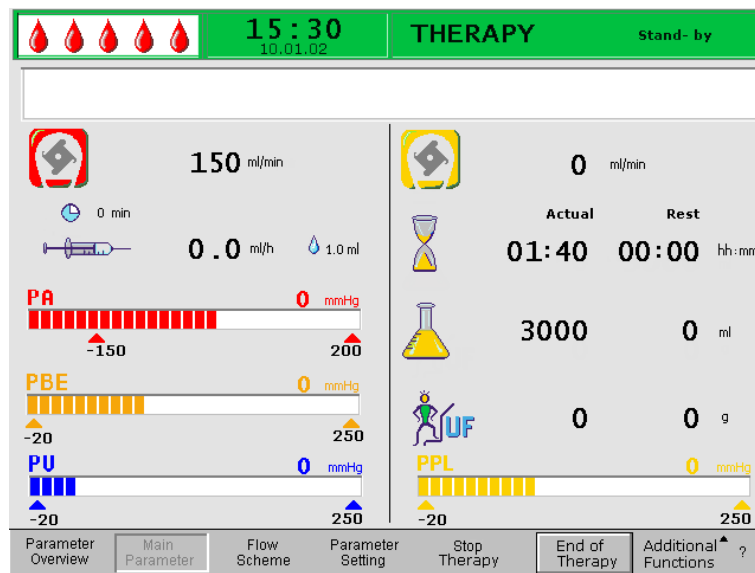

The cursor automatically points to the <End of Therapy> command in the menu bar.



- Confirm with

- Confirm the message <W35: Activate reinfusion?> in the warning window by pressing the  key to change to the reinfusion phase.

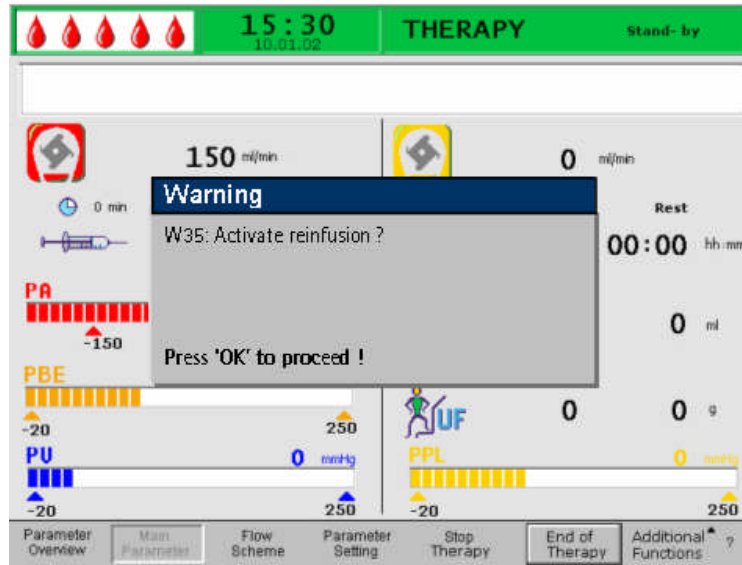

Risk to patient due to blood and/or plasma loss and subsequent blood pressure drop in case of a premature termination of the therapy without reinfusion of the plasma and/or blood volume.

- Volume substitution, application of an albumin solution as prescribed by the handling physician.
- Request the patient to drink more liquids than usual.

5.3 PARAMETER SETTING

5.3.1 Parameter Setting in the <Main Parameter> Screen

➤ To set the parameters, select the <Parameter Setting> menu item with the cursor in the <Main Parameter> screen and activate it with .

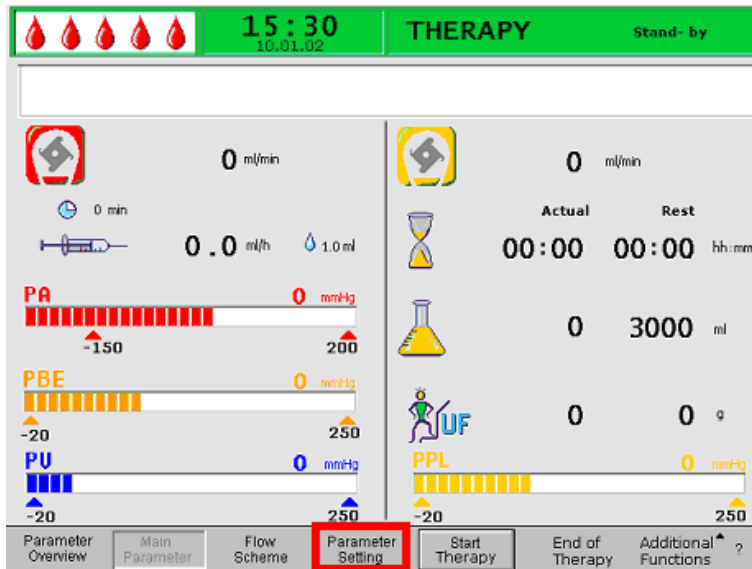

All parameters which can be changed are displayed in red. The currently selected parameter has a grey background. The Setting window displays the allowable range.

➤ Using the rotary knob, select the individual parameters.

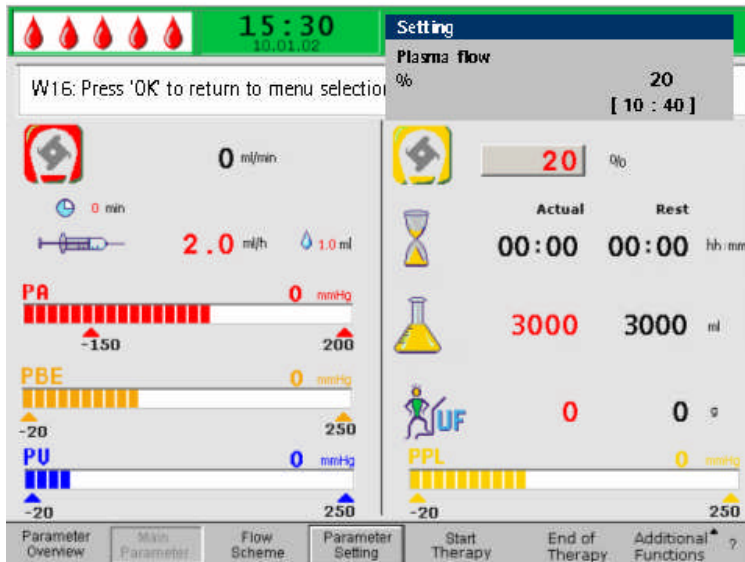

The following parameters can be set in therapy phase:



Plasma flow rate (%)



Plasma volume (ml)



Balance (g)



Heparin flow rate (ml/h)



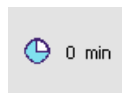

Heparin bolus (ml)

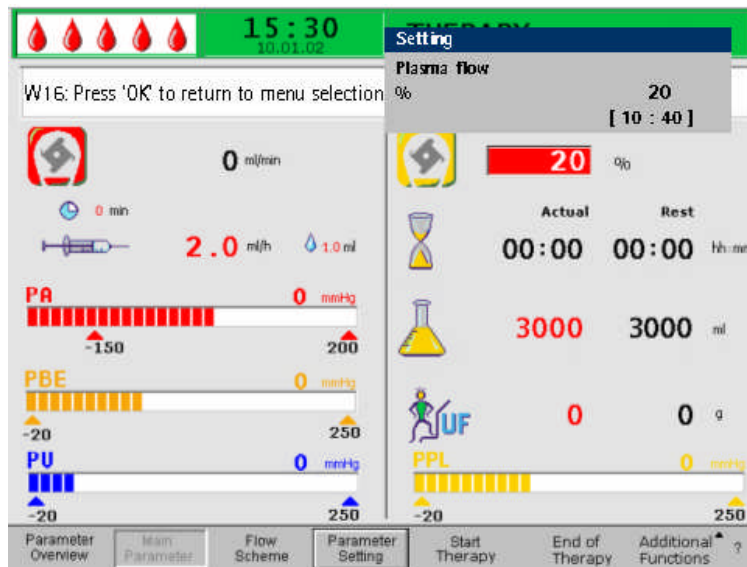

Autostop heparin (min)

- Press the  key to select the parameter to be changed. The field is shown with a red background and white labeling.



- Perform the desired change using the rotary knob and confirm with the  key.

➤ The changing of the following parameters must be confirmed with the  key since they are relevant to patient safety:

- Plasma flow rate
- Plasma volume
- Balance
- Heparin bolus
- Heparin flow rate

If a parameter is relevant to patient safety, the currently set value is shown in the Setting window above the setting range. In addition, the LEDs above the  key blink.

➤ To quit the screen for setting the parameters, press the  key. The cursor changes back to the menu bar and the menu item <Start Therapy> of the Parameter Overview screen.

If no settings are changed for more than 15 seconds, the screen automatically changes back to the previously set screen.

For more details see chapter 4.2.1.

5.3.2 Parameter Setting in the <Parameter Overview> Screen

➤ Using the rotary knob and  change to the <Parameter Overview> screen.

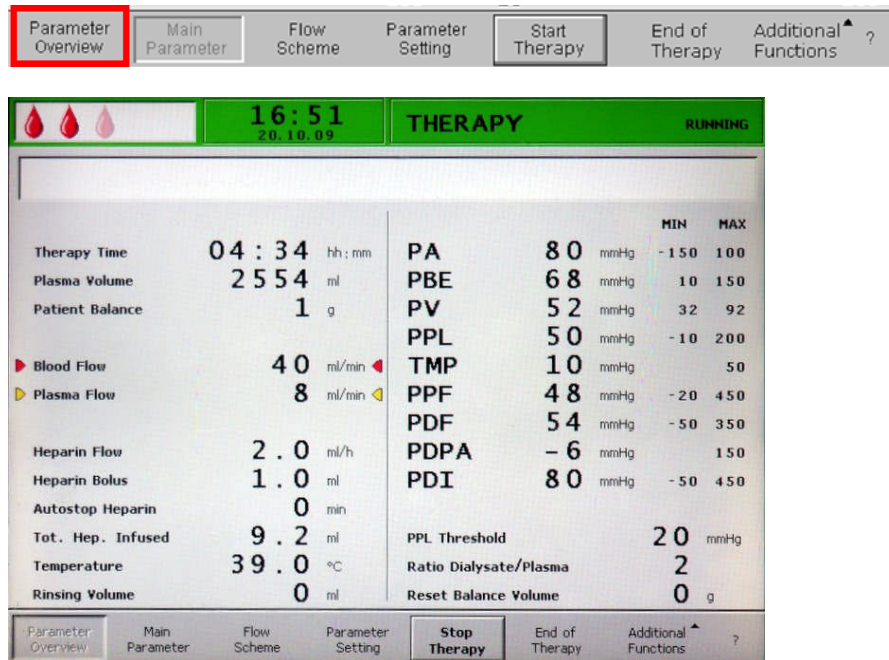

The screenshot shows the 'Parameter Overview' screen with a menu bar at the top containing: Parameter Overview (highlighted), Main Parameter, Flow Scheme, Parameter Setting, Start Therapy, End of Therapy, and Additional Functions. The main display area shows the following parameters:

Parameter	Value	Unit	MIN	MAX
Therapy Time	04 : 34	hh : mm		
Plasma Volume	2 5 5 4	ml		
Patient Balance	1	g		
Blood Flow	4 0	ml/min		
Plasma Flow	8	ml/min		
Heparin Flow	2 . 0	ml/h		
Heparin Bolus	1 . 0	ml		
Autostop Heparin	0	min		
Tot. Hep. Infused	9 . 2	ml		
Temperature	3 9 . 0	°C		
Rinsing Volume	0	ml		
PA	8 0	mmHg	- 1 5 0	1 0 0
PBE	6 8	mmHg	1 0	1 5 0
PV	5 2	mmHg	3 2	9 2
PPL	5 0	mmHg	- 1 0	2 0 0
TMP	1 0	mmHg		5 0
PPF	4 8	mmHg	- 2 0	4 5 0
PDF	5 4	mmHg	- 5 0	3 5 0
PDPA	- 6	mmHg		1 5 0
PDI	8 0	mmHg	- 5 0	4 5 0
PPL Threshold	2 0	mmHg		
Ratio Dialysate/Plasma	2			
Reset Balance Volume	0	g		

The bottom menu bar contains: Parameter Overview, Main Parameter, Flow Scheme, Parameter Setting, Stop Therapy (highlighted), End of Therapy, and Additional Functions.

➤ To set parameters, select the <Parameter Setting> menu item and activate it with .

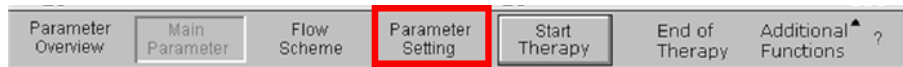

All parameters which can be changed are displayed in red. The currently selected parameter has a gray background. The Setting window displays the allowable range. Using the rotary knob, you can select the individual parameters.

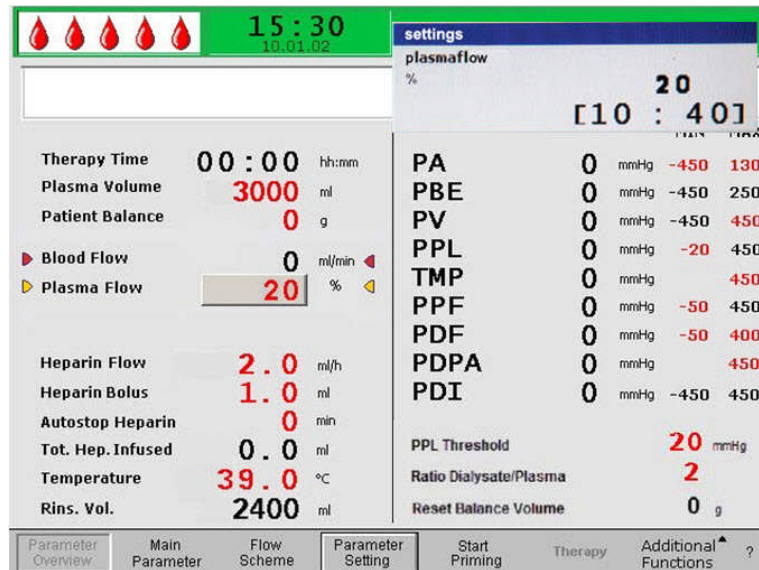



The following parameters can be set in the therapy phase:

- Plasma volume (ml)
- Balance (g)
- Plasma flow (%)
- Heparin flow (ml/h)
- Heparin bolus (ml)
- Autostop heparin (min)
- Temperature (°C)
- PA min (mmHg)
- PA max (mmHg)
- PV MIN window (mmHg)
- PV MAX window (mmHg)
- PPL min (mmHg)
- TMP max (mmHg)
- PPF min (mmHg)
- PDF min (mmHg)
- PDF max (mmHg)
- PDPA max (mmHg)
- PPL threshold (mmHg)
- Ratio dialysate/plasma

- Press  to select the parameter to be changed. The field is shown with a red background and white labeling.



- Perform the desired change using the rotary knob and confirm it with .

The changing of the following parameters must be confirmed with  since they are relevant to patient safety:

- Plasma flow rate
- Plasma volume
- Balance
- Heparin flow rate
- Heparin bolus
- PA min
- PA max
- PV MIN window (mmHg)
- PV MAX window (mmHg)
- Ratio dialysate/plasma

If a parameter is relevant to patient safety, the currently set value is shown in the Setting window above the setting range. In addition, the LEDs above the  key blink.



Risk to patient due to blood loss since increasing the PV MIN window elevates the likelihood of an unrecognized removal of the venous access.

- Do not cover the venous access.
- Keep the patient under continuous surveillance.

- To quit the screen for setting the parameters, press the  key. The cursor changes back to the menu bar and the menu item <Start Therapy> of the Main Parameter screen.

If no settings are changed for more than 15 seconds, the screen automatically changes back to the previously set screen.

For more details see chapter 4.2.2.

5.3.3 Parameter Setting in the <Flow Scheme> Screen

➤ Using the rotary knob and the  key, change to the <Flow Scheme> screen.

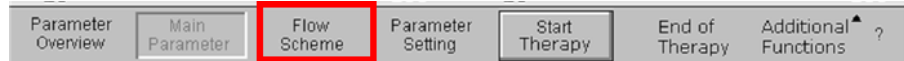

➤ To set the parameters, select the <Parameter Setting> menu item with the cursor in the <Flow Scheme> screen and activate it with .

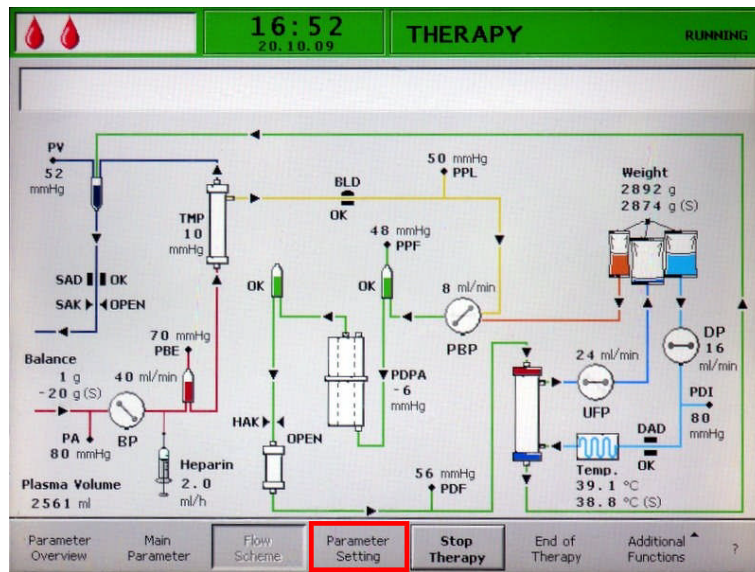

The screen changes to the Setting screen of the Parameter Overview and the settings may be changed as described in chapters 5.3.2 and 4.2.2.



5.4 ADDITIONAL FUNCTIONS

5.4.1 Premature Termination of Therapy

- The therapy can be terminated prematurely at any time by selecting <End of Therapy> in the menu bar and activated by pressing the  key.

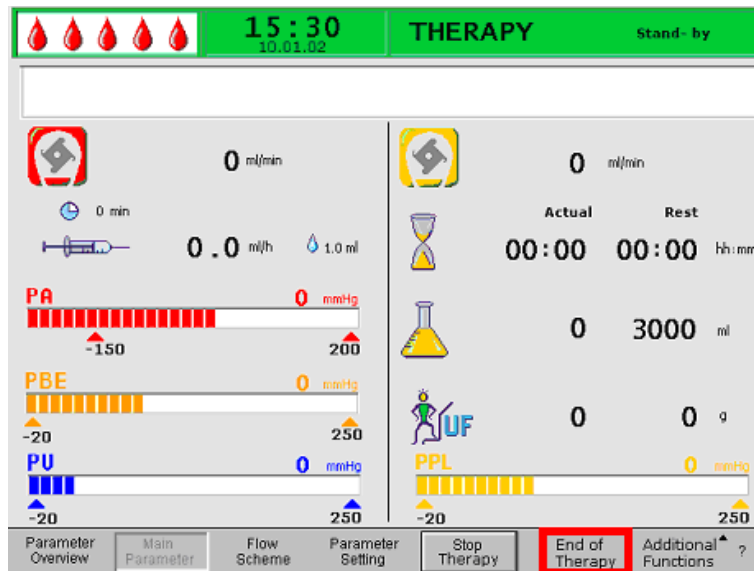

If the therapy is prematurely terminated, the warning window with the following message is first displayed <W35: Activate reinfusion?> and must be confirmed with the  key.

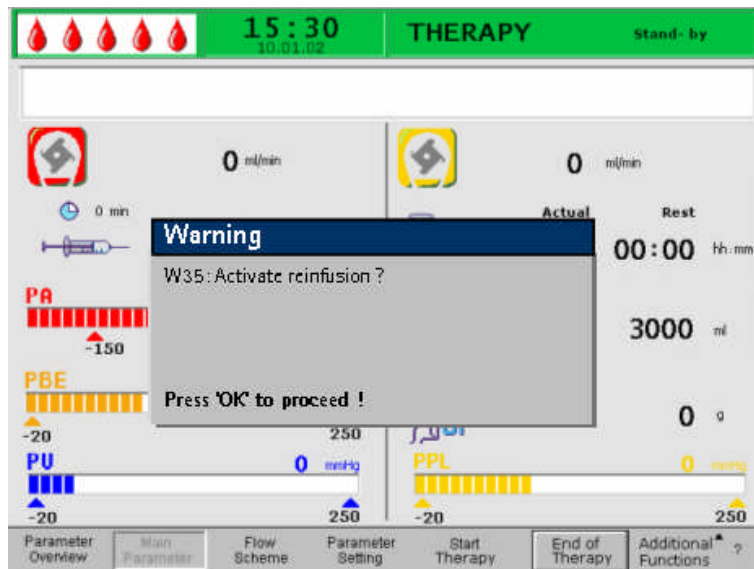

The next procedure is described in chapter 6, Reinfusion.

5.4.2 Premature Termination of Therapy by Power Failure

In case of power failure longer than 5 minutes only the blood can be returned manually. Use the crank at the rear side of the machine (see 2.3.5).

- Connect the arterial line to saline solution.
- Fit the crank into the pump roller and turn the pump by hand clockwise until the blood is reinfused back totally.
- Infuse additional fluid (saline solution, electrolytes) in a proper amount to compensate the plasma loss remaining in the plasma circuit or encourage the patient to drink more after therapy.



Avoid manual reinfusion of plasma from the plasma circuit because this plasma is mixed with acetate buffer and in case of power failure dialysis step is not enabled.

5.4.3 Additional Functions

➤ From the <Main Parameter>, <Parameter Overview> and <Flow Scheme> screens, the <Additional Functions> menu item can be selected and activated by pressing the



key.

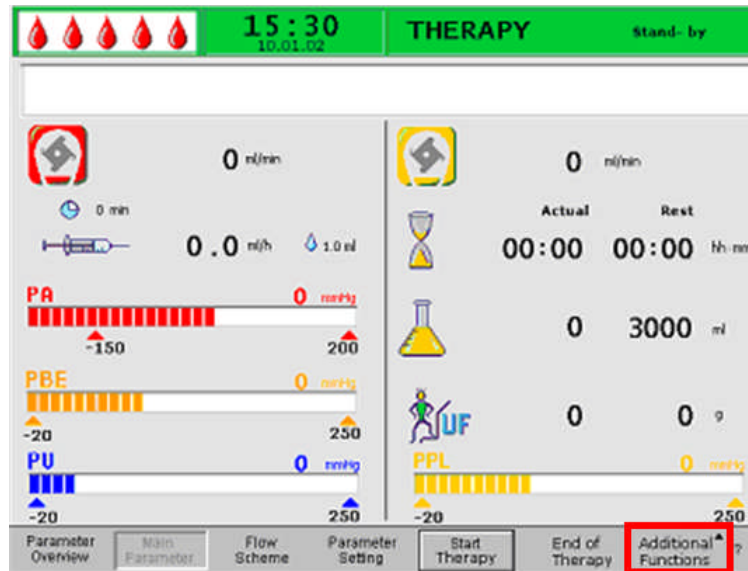

When <Additional Functions> is selected, a submenu with the following selections is opened:

- Stop bolus – active only while the heparin bolus is administered
- Heparin bolus – active during the therapy
- Balance reset – active only for improper balancing > 200 g (for a more detailed description, see Problem Correction).

The active menu items are shown in black labeling, and the inactive items in gray labeling. The selected active field has a green background.

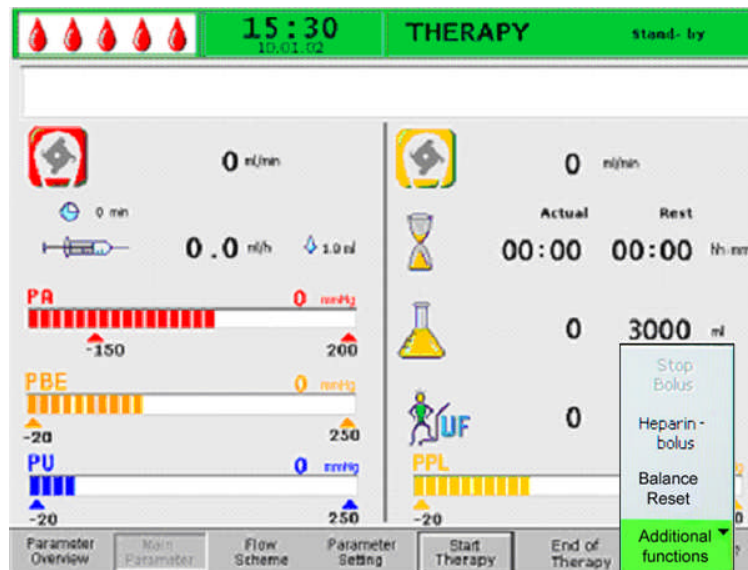



Risk to patient due to impact on patient's fluid balance.

- Perform the balance reset only when you are sure that the balancing error was triggered by a leakage of the dialysis and/or waste bags and does not concern the patient!
- If you are not able to detect the root cause: stop therapy and call a technician!

5.4.4 Heparin Bolus

- To administer a heparin bolus during the therapy, select the <Heparin Bolus> menu item and confirm the input with the  key.

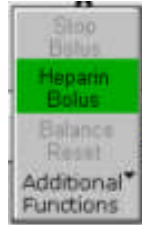

The warning window is displayed with the following message: <W33: Heparin bolus?>.



- Confirm the message with the  key if you wish to administer the heparin bolus.
- If you do not wish to administer the heparin bolus, wait for the warning window to disappear after 5 seconds.

While the heparin bolus is administered, the <Stop Bolus> menu item in the submenu is active.



The heparin bolus can be interrupted at any time by pressing the  key. During heparin administration, the symbol of heparin bolus (drop) alternates between a large red drop and a small blue drop.

After heparin administration, the softkey <Stop Therapy> is automatically selected.



6	Reinfusion	3
6.1	PLASMA REINFUSION	3
6.2	BLOOD REINFUSION	6
6.3	TERMINATING THE TREATMENT	7
6.4	PARAMETER SETTING	9
6.4.1	Parameter Setting in the <Main Parameter> Screen	9
6.4.2	Parameter Setting in the <Parameter Overview> Screen	11
6.4.3	Parameter Setting in the <Flow Scheme> Screen	14
6.4.4	Additional Functions	15

6 Reinfusion

6.1 PLASMA REINFUSION

After terminating the therapy as described in chapter 5.2, the screen display changes to the Reinfusion screen.

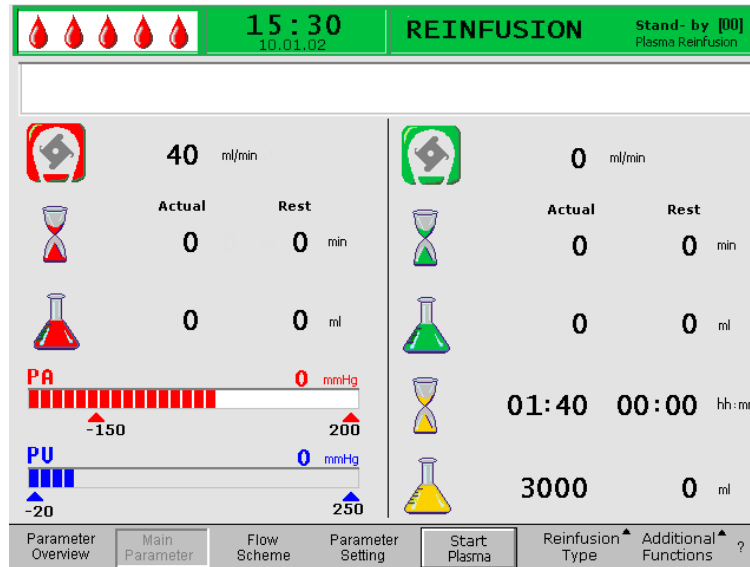

Display Area of the Reinfusion Screen



Blood flow in ml/min

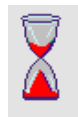

Blood reinfusion time in min



Blood reinfusion volume in ml



Reinfusion flow in ml/min



Reinfusion time in min



Reinfusion volume in ml



Therapy time [actual/rest] in hh:mm



Plasma volume [actual/rest] in ml

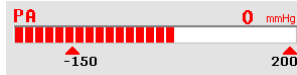

Arterial pressure in mmHg





Venous pressure in mmHg

After the change to the reinfusion phase, the blood flow is not stopped but set automatically to 30 ml/min.

The default setting of the plasma reinfusion volume is 400 ml.

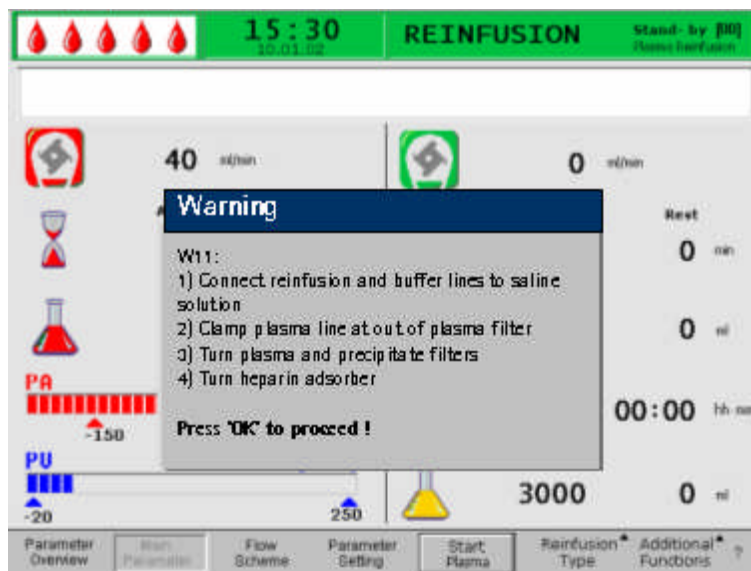
The next steps for preparing the reinfusion are summarized in the warning window.



- Check that the two non-PVC bags with physiological saline solution are hanging on the IV-pole.
- Check whether the reinfusion line is connected to the 1500 ml compartment of the saline bag and the seal of the saline bag is broken.
- Open the clamps on the reinfusion line.
- Take the buffer bag from the load cell. Remove the buffer line from the buffer bag and connect the buffer line to the 1500 ml saline bag.
- Open the break seal of the saline bag and open the clamp on the buffer line.
- Close the clamp on the plasma line directly after the plasma filter.
- Turn over the plasma filter, the precipitate filter and the heparin adsorber.
- After performing all steps, confirm with the **OK** key.
- Start plasma reinfusion by selecting the <Start Plasma> menu item in the menu bar and pressing the  key.

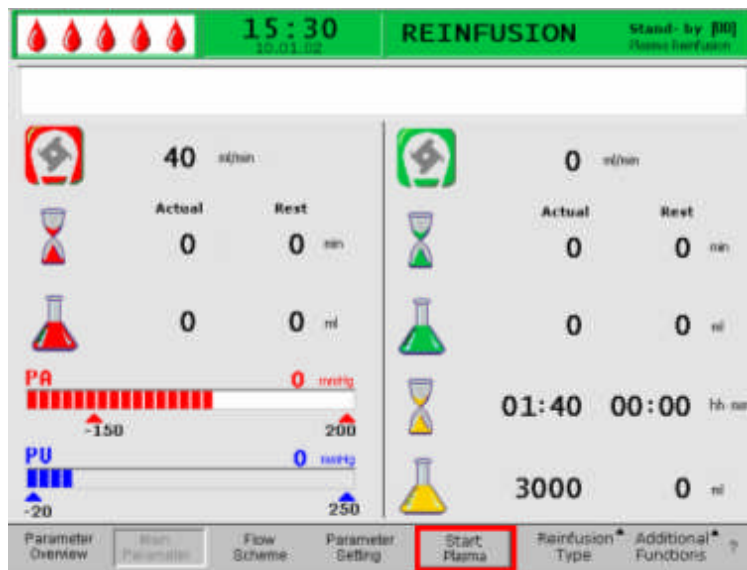

! If the precipitate filter pressure rises during the plasma reinfusion because of the high filter saturation, the reinfusion flow should be reduced.

CAUTION Risk to patient due to an excessively fast plasma reinfusion. Some patients experience flushing on the arm used for reinfusion and in the throat area, nausea and/or headaches.

- The blood flow should be at least 10 ml/min faster than the reinfusion flow.
- Otherwise: Reduce the reinfusion flow to approx. 20 ml/min and increase the blood flow as much as possible (approx. 80 ml/min), so that flow rates similar to those during therapy are achieved.

CAUTION Risk to patient due to an excessively plasma/blood reinfusion step. Excessively performed reinfusion can lead to an overload of saline solution to the patient.

- Comply with the recommended reinfusion volume.
- Exceed the reinfusion volume only if a filter has been changed during therapy.

When the reinfusion volume is reached, all pumps except the blood pump stop. The blood flow is maintained. The default setting of the plasma reinfusion volume is 400 ml.

The warning window on the display explains the way to continue:

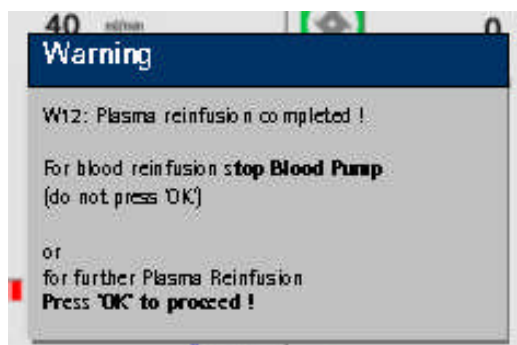

6.2 BLOOD REINFUSION



- Stop the blood pump with .

i

As long as the blood pump is running the menu <Blood Reinfusion> is not active.

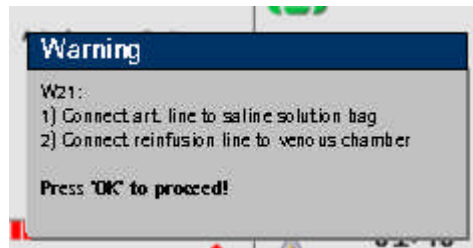
The next steps are summarized in a Warning window.



- Remove the arterial line from the patient's arterial access and connect the line to the 500 ml saline bag on the IV-pole.
- Close the clamp of the reinfusion line.
- Take the reinfusion line from the saline bag and screw it to the port of the venous chamber.
- Open the clamps of the reinfusion line and the port.
- Confirm the Warning window with the  key.
- Start the blood pump with the  key

The default setting of the blood reinfusion volume is 300 ml.

When a blood reinfusion volume of 150 ml has been reached warning W41 appears:

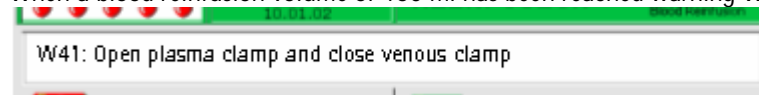

- Open the clamp of the plasma line after the plasma filter.
- Close the clamp on the venous line to the venous chamber.

The saline solution is now pumped through the membrane of the plasma filter to the plasma side of the filter. In this manner, the plasma from the plasma filter is also reinfused.

The blood pump stops automatically when the set blood reinfusion volume is reached.

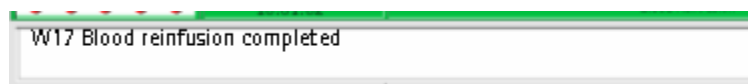

- Remove the venous line from the patient's venous access. For the patient, the treatment is now completed.

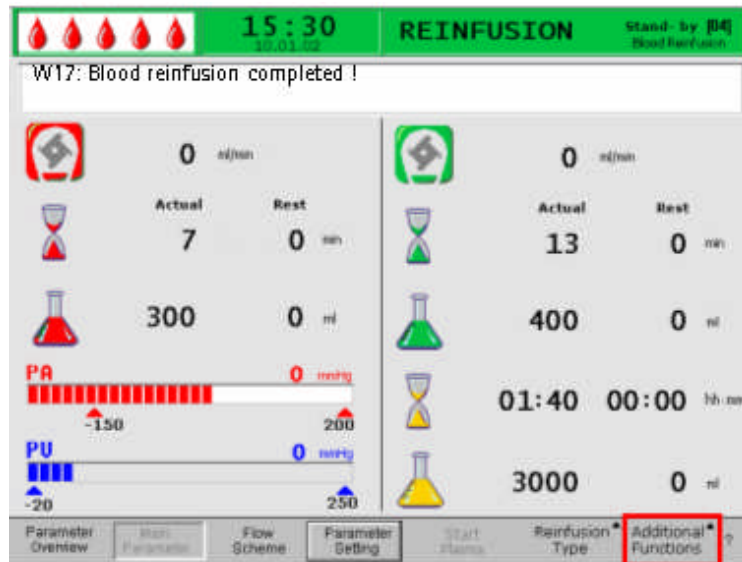

6.3 TERMINATING THE TREATMENT

- Note down all necessary treatment data of the patient.
- Select the <Additional Functions> menu item in the menu bar and open the submenu by pressing .



- Select menu item <New Therapy>.



- Confirm with .
- Confirm the message in the Warning window <W36: Are you sure to start a new therapy? Return to this therapy is not possible> with  to return to the start screen.

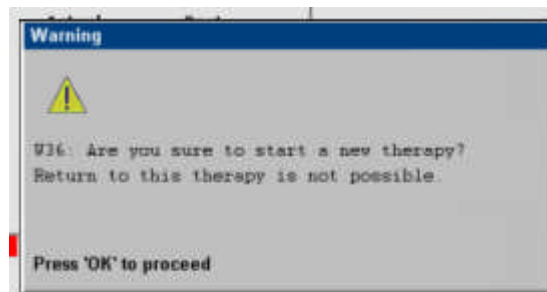

! Please note that all data of the treatment just performed are deleted when you quit the reinfusion phase by pressing the  key.

- Remove all disposables from the machine and dispose of it accordingly.

The display returns to the start screen and you can now prepare the machine for another treatment or switch off the machine.

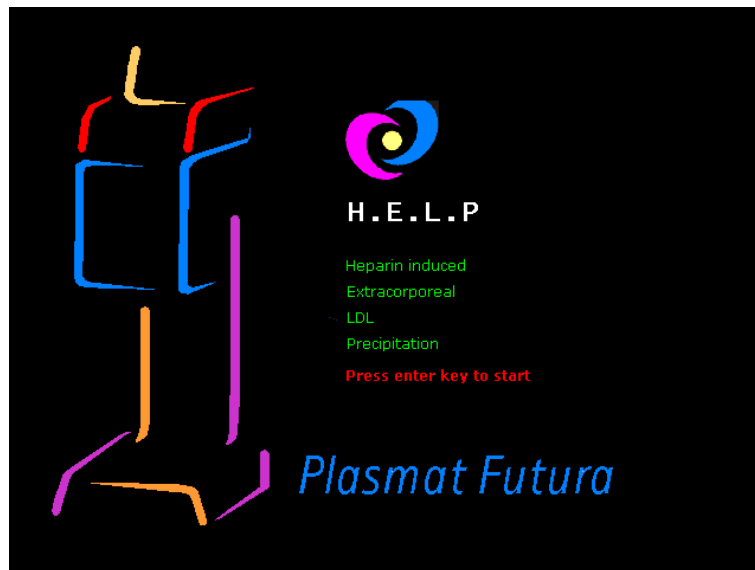

6.4 PARAMETER SETTING

6.4.1 Parameter Setting in the <Main Parameter> Screen

- To set the parameters, select the <Parameter Setting> menu item with the cursor in the <Main Parameter> screen and activate it with .

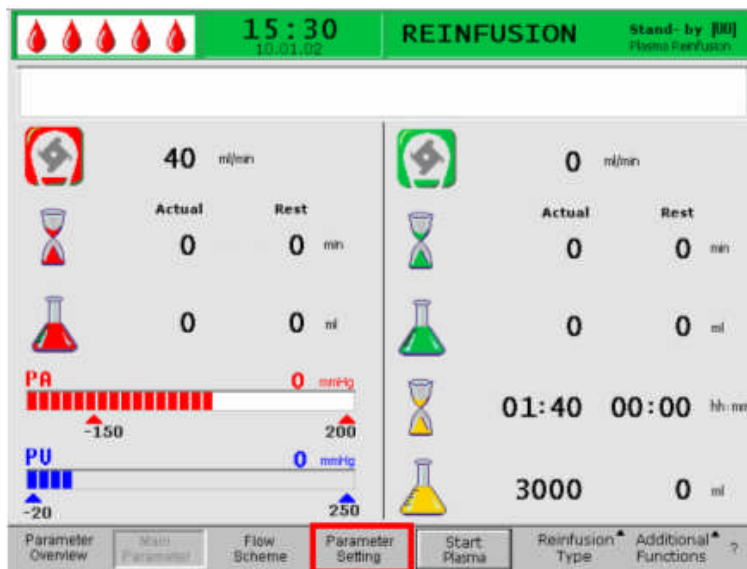

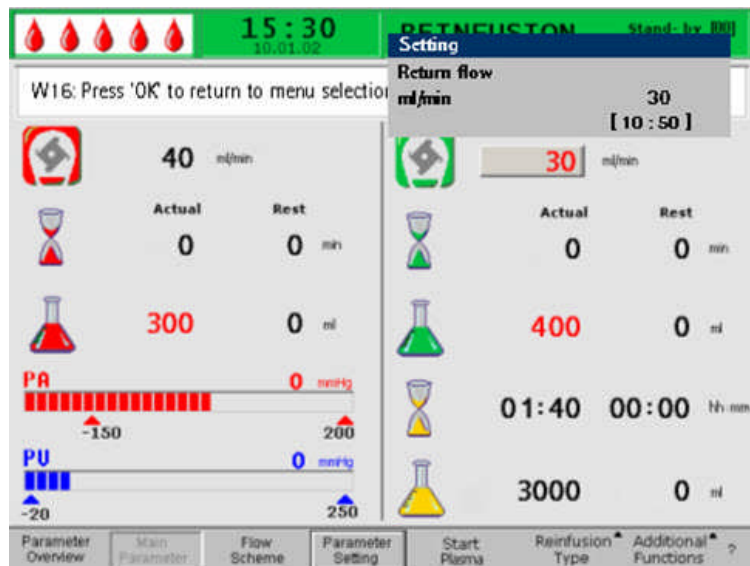

All parameters that can be changed are displayed red.





The currently selected parameter has a grey background. The Setting window displays the allowable range.

- Using the rotary knob, select the individual parameters.

The following parameters can be set in the reinfusion phase:

	Symbol	Default setting	Range	Step size
Reinfusion flow		30 ml/min	10 – 50 ml/min	5 ml/min
Plasma reinfusion volume		400 ml	400 – 1000 ml	50 ml
Blood reinfusion volume		300 ml	100 – 600 ml	50 ml

- Press the  key to select the parameter to be changed. The field is shown with a red background and white labeling. Perform the desired change using the rotary knob and confirm it with the  key.

The changing of the following parameters must be confirmed with the  key since they are relevant to patient safety:

- Reinfusion flow
- Blood reinfusion volume

Which parameters are relevant to patient safety can be seen in the Setting window. The currently set value is shown above the setting area. In addition, the LEDs above the  key blink.

- To quit the screen for setting the parameters, press the  key. The cursor changes back to menu item <Start Plasma> of the menu bar of the Parameter Overview screen.

If no settings are changed for more than 15 seconds, the screen automatically changes back to the previously set screen.

6.4.2 Parameter Setting in the <Parameter Overview> Screen

➤ Using the rotary knob and the  key, change to the <Parameter Overview> screen.

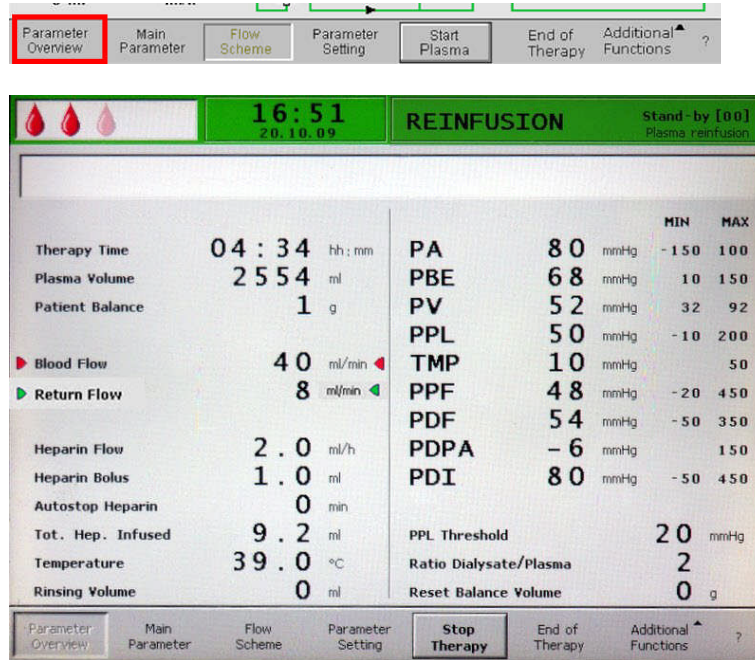

➤ To set the parameters, select the <Parameter Setting> menu item with the cursor in the <Parameter Overview> screen and activate it with the  key.



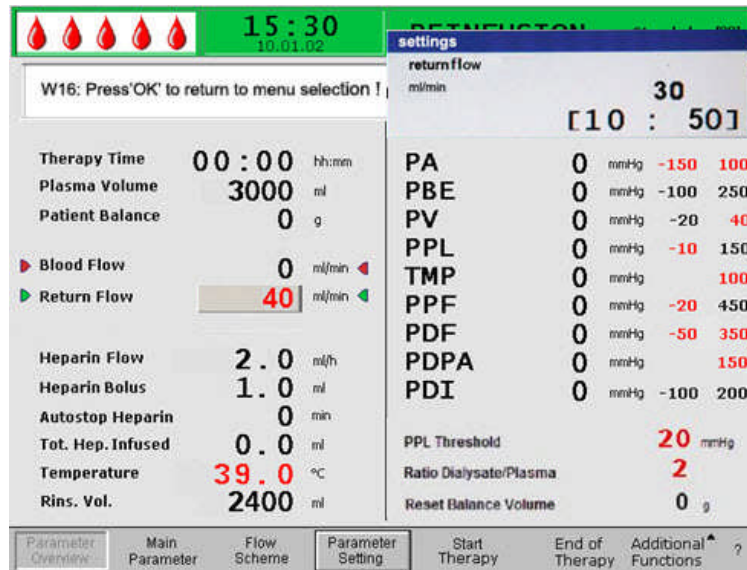

All parameters which can be changed are displayed in red. The currently selected parameter has a grey background. The Setting window displays the allowable range. Using the rotary knob, you can select the individual parameters.

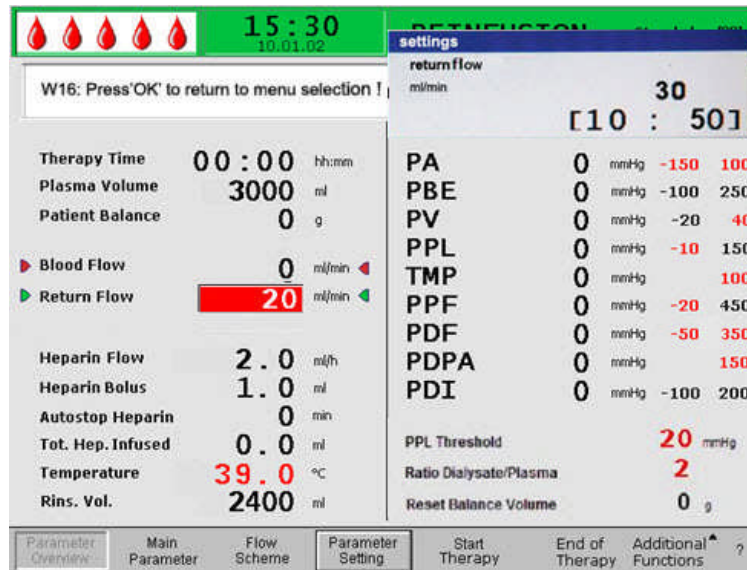

The following parameters can be set in the reinfusion phase:

- Reinfusion flow (ml/min)
 - Temperature (°C)
 - PA min (mmHg)
 - PA max (mmHg)
 - PV MIN window (mmHg)
 - PV MAX window (mmHg)
 - PPL min (mmHg)
 - TMP max (mmHg)
 - PPF min (mmHg)
 - PDF min (mmHg)
 - PDF max (mmHg)
 - PDPA max (mmHg)
 - PPL threshold (mmHg)
 - Ratio dialysate/plasma
- Press the  key to select the parameter to be changed. The field is shown with a red background and white labeling.





➤ Perform the desired change using the rotary knob and confirm it with the  key.

The changing of the following parameter must be confirmed with the  key since it is relevant to patient safety:

- Reinfusion flow in ml/min
- PA min in mmHg
- PA max in mmHg
- PV MIN window (mmHg)
- PV MAX window (mmHg)
- Ratio Dialysate/Plasma

Plasma and blood reinfusion volume can be set only in the <Main Parameter> screen.

Parameters relevant to patient safety can be seen in the Setting window. The currently set value is shown above the setting area. In addition, the LEDs above the  key blink.

➤ To quit the screen for setting the parameters, press the  key. The cursor changes back to the menu item <Start Plasma> of the menu bar of the Parameter Overview screen.

If no settings are changed for more than 15 seconds, the screen automatically changes back to the previously set screen.

6.4.3 Parameter Setting in the <Flow Scheme> Screen

➤ Using the rotary knob and the  key, change to the <Flow Scheme> screen.

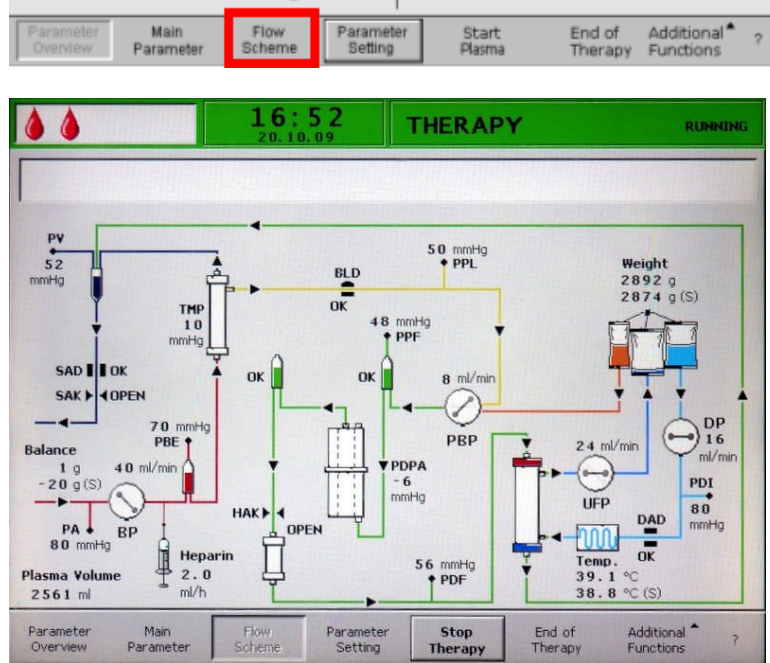

➤ To set the parameters, select the <Parameter Setting> menu item with the cursor in the <Flow Scheme> screen and activate it with .





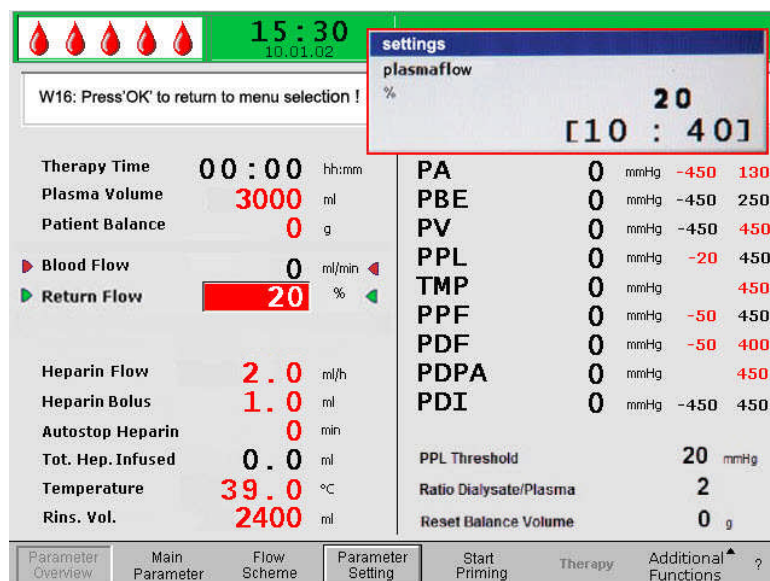

The screen changes to the Setting screen of the Parameter Overview and you can perform here all settings as described in chapter 6.4.2.

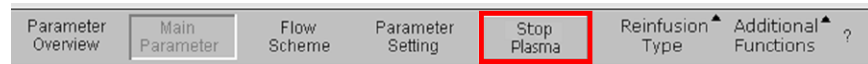

6.4.4 Additional Functions

- At any time during Plasma Reinfusion, you can prematurely terminate the Plasma Reinfusion by selecting <Stop Plasma> in the menu bar and activating it with .



- To move on to Blood Reinfusion, stop the blood pump with the  key.
- Select the <Reinfusion Type> menu item and press the  key. The respective submenu is opened. Select the <Blood Reinfusion> menu item in this submenu and confirm it with the  key.

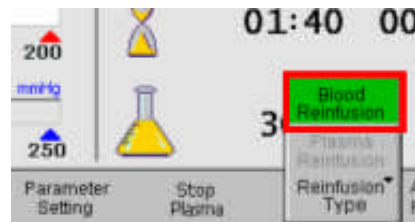

The sub menu <Blood Reinfusion> is active only if the blood pump is stopped.

- After selection of <Blood Reinfusion> a warning window appears: <W21: 1) Connect art. line to saline solution bag 2) Connect reinfusion line to venous chamber> which must be confirmed with the  key.

The next procedure is described in section 6.2 Blood Reinfusion.

Under the <Additional Functions> menu item you can select more functions.

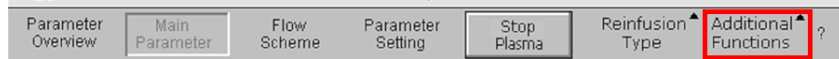

The <Back to Therapy> menu item is active only during plasma reinfusion and allows return to therapy.





The <New Therapy> menu item is active only during blood reinfusion. It allows for complete termination of the treatment and a return to the Start screen (see chapter 6.3).



7 Basic and Default Settings..... 3

7 Basic and Default Settings

By simultaneously pressing the  key and the  key you can go to the Service screen from any screen after the self-test.

Technical information is displayed on the left side of the screen (1).

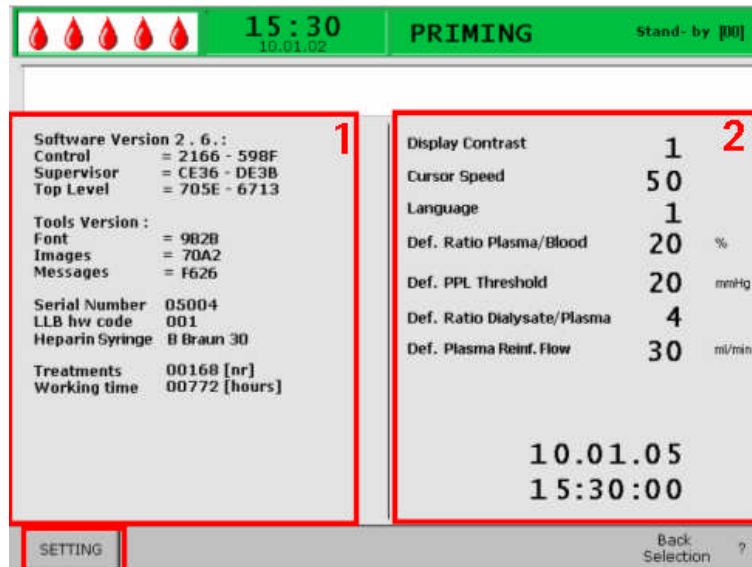

The parameters set by default are displayed on the right side of the screen (2).

➤ To change the parameters, select the <SETTING> menu item and confirm by pressing the  key.

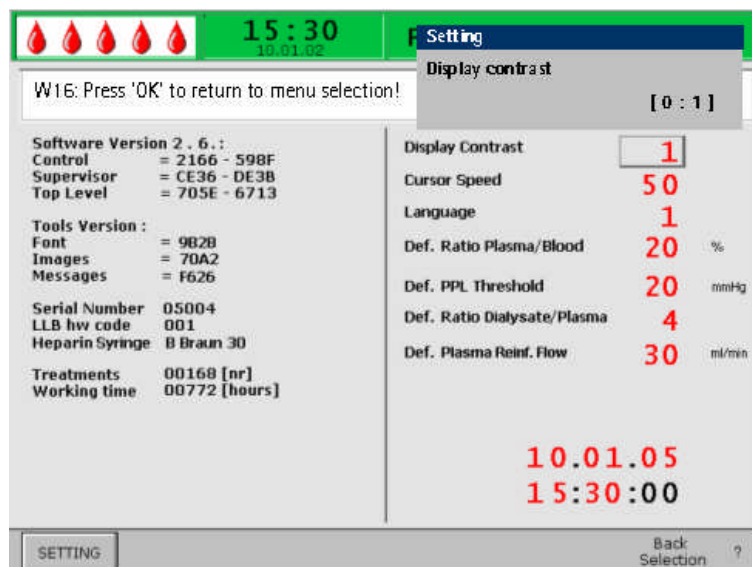

All parameters that can be changed are displayed in red. The currently selected parameter has a grey background. The Setting window displays the allowable range. Using the rotary knob, select the individual parameters.



- Press the  key to activate the parameter to be changed. The field is shown with a red background and white labeling. Perform the desired change using the rotary knob and confirm it with the  key.

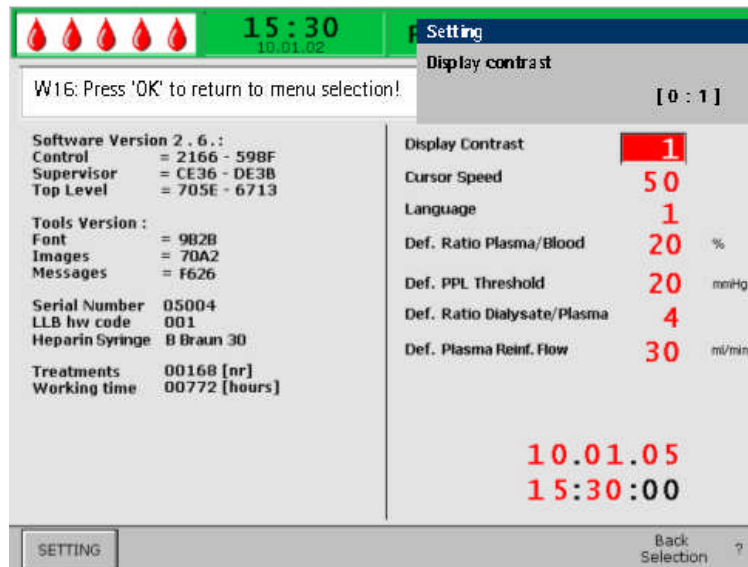

The following parameters can be changed in the Service screen:

Display contrast

Two settings are available to adjust the display contrast:
0 = dark, 1 = bright

Cursor speed

The speed with which the cursor moves over the screen can be adjusted in steps of 10 in the range from 50 to 200.

Language

Italian (0), English (1) and German (2) can be selected for screen display.

Def. Ratio Plasma/Blood

This parameter sets the percentage share of plasma flow to blood flow during the separation of plasma. The setting is performed in steps of 1 % in the range from 10 % to 40 %. The default setting is 20 %.

The plasma/blood ratio is relevant to patient safety, therefore confirmation of its change is required.

Def. PPL Threshold

This parameter sets the limiting value for the automatic plasma flow adaptation during therapy. The setting is performed in steps of 5 mmHg in the range from -20 to 120 mmHg. The default setting is 20 mmHg.

Def. Ratio Dialysate/Plasma

This parameter sets the ratio of the dialysate flow in relationship to the plasma flow during the therapy and reinfusion. The setting is performed in steps of 1 in the range from 2 to 4. The default setting is 2.

The ratio of dialysate/plasma is a parameter relevant to patient safety, therefore confirmation of its change is required.

Def. Plasma Reinfusion Flow

This parameter sets the Plasma Reinfusion Flow default value on the Default screen: in the range of 10 - 50 ml/min (First default: 30 ml/min). In every therapy the Reinfusion Flow is set to this default value after a new therapy selection.

Date

Date, month and year are set successively.

Time

Hours and minutes are set successively.

The modification of the following parameters must be confirmed with the  key since they are relevant to patient safety:

- Def. Ratio Plasma/Blood
- Def. Ratio Dialysate/Plasma.

If a parameter is relevant to patient safety, the currently set value is shown in the Setting window above the setting range. In addition, the LEDs above the  key blink.

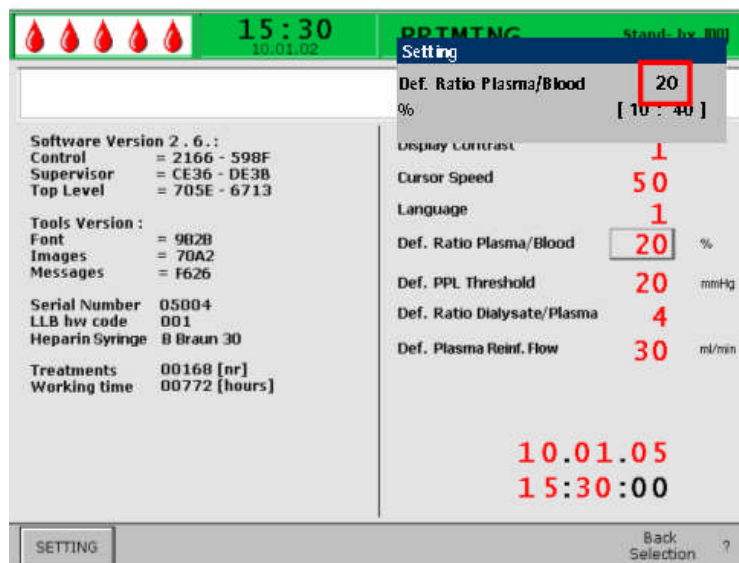

➤ To quit the screen for setting the parameters, press the  key. The cursor changes back to the menu bar of the Service screen.

If no settings are changed for more than 15 seconds, the screen automatically reverts back to the previously set screen.

- In the menu bar, select <Back Selection>, confirm this input with the  key and return to the Start screen.

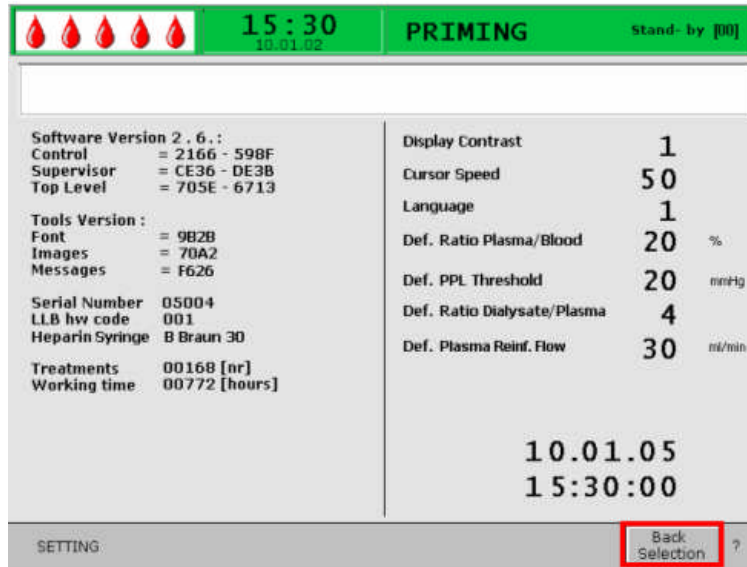

8	Selftests, Alarms and Problem Correction	3
8.1	SELFTEST	3
8.1.1	Hardware Selftest	3
8.1.2	Selftest Duration and Alarm Code.....	6
8.2	DYNAMIC TESTS AND CONTROLS DURING THERAPY AND REINFUSION	12
8.2.1	Blood Leak Detection	12
8.2.2	Connection Test in Therapy and Reinfusion	13
8.2.3	Control of Ultrafiltration.....	13
8.3	ALARMS.....	14
8.3.1	Alarm Concept	14
8.3.2	List of Alarms.....	16
8.4	WARNINGS.....	29
8.4.1	Warning Concept	29
8.4.2	List of Warnings.....	31
8.5	PROBLEM CORRECTION	38
8.5.1	Balance Reset	38
8.5.2	Deaeration of the Heparin Adsorber	40
8.5.3	Changing the Solution Bags	40
8.5.4	Changing the Plasma Filter	42
8.5.5	Changing the H.E.L.P. Precipitate Filter	43
8.5.6	Changing the H.E.L.P. Heparin Adsorber	44
8.5.7	Changing the H.E.L.P. Ultrafilter	45

8 Selftests, Alarms and Problem Correction

8.1 SELFTEST

8.1.1 Hardware Selftest

After the machine has been switched on, the system performs a series of hardware selftests. During these tests no disposables must be installed on the machine (solution bags, lines).

The screen shows the controller tests on the left side and the supervisor tests on the right side.

The <Retest> menu item blinks during the selftest.

Positive selftest:

- All tested positions are marked with "PASSED".
- All three rows of numbers are completely presented in the correct sequence (0 1 2 3 4 5 6 7 8 9) completely and in the three fonts that can be displayed by the machine.
- After a positive selftest, the <End> menu item is automatically activated.

➤ Confirm with  to change to the Start screen.

Negative selftest:

- The affected positions are marked "Failed" and/or
- The rows of numbers are not in the correct sequence or incomplete.
- The <Retest> function is automatically selected in this case.

➤ Confirm with  to start the retest.

See chapter 8.1 for detailed information concerning the selftests.

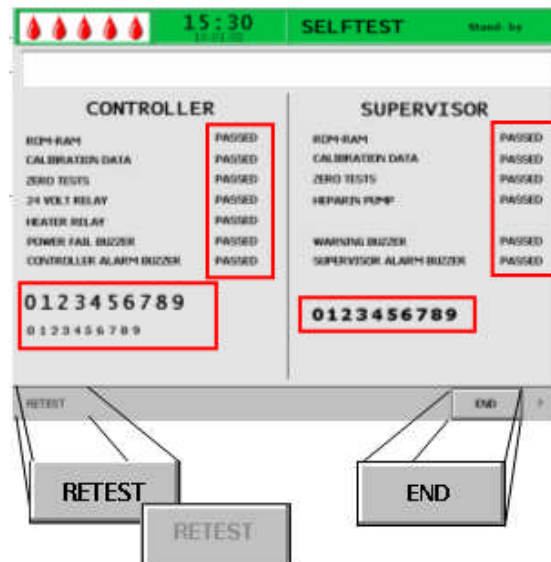



The different acoustic signals of the machine are also tested during the selftest. Please make sure the acoustic signals are audible.
Make sure that all LEDs are blinking.



- During the selftest ensure that the load cell is not equipped with solutions and the pressure transducers are not screwed to the respective connections!
- Preparations for therapy may only start when all selftests are performed successfully.

Numeric test

This test displays the numeric strings (0 1 2 3 4 5 6 7 8 9) in the three different fonts which the machine has available. The user has to check whether the sequence is correct.

If one of the selftests fails, a relevant warning is displayed. In this case, ensure that the machine is in the initial state. Then another selftest can be performed after correction of the cause of the error by selecting the <Retest> menu item in the menu bar and pressing the  key.

When the hardware tests and the numeric test have been successfully completed, the Start screen is displayed by selecting the <End> menu item in the menu bar and confirming with the  key.

LED Test

During the execution of selftests, the hardware performs selftests of the LEDs by switching them on intermittently:

-  key
-  key
-  key.

The user must make sure that all LEDs operate correctly.

T0 tests

The T0 tests are performed continuously and periodically over the complete operating period of the machine.

Static T1 tests

The static T1 tests are performed after the machine is switched on. The therapy can be started only when all T1 tests were performed without error.

Dynamic T1 tests

Dynamic T1 tests are performed during the priming and rinsing phase to ensure the correct installation of the lines.

The system performs various dynamic selftests during the priming and rinsing phase to ensure the functionality of the following units:

- Load cell
- Blood leak detector (BLD)
- Dialysate air detector (DAD)
- Safety air detector (SAD)
- Arterial pressure (PA)
- Plasma prefilter pressure (PBE) and venous pressure sensors (PV)

- Pumps
- Heating
- The temperatures of the dialysate measured by the controller and the supervisor, respectively, are compared.

Various selftests are performed during the entire therapy in periodic intervals for the safety of the patient. The following parameters are monitored:

- Fluid weight on the load cell
- Blood leak detector (BLD)
- Safety air detector (SAD)

Proceed as follows in the case of a failed test:

- 1) Suppress the acoustic alarm with the  key
- 2) Follow the instructions on the monitor and determine which test failed.
- 3) Determine and correct the displayed cause, if possible.

Repeat the test by again pressing the  key.

8.1.2 Selftest Duration and Alarm Code

Test	Time [seconds]	Alarm Code
T0 Tests by the Controller		
Proper Supervisor operation Periodical life signal is received from Supervisor.	3 s	A99
Functional states of controller and supervisor are identical Verification whether the controller and the supervisor have the same working state.	5 s	A02
Arterial pressures of controller and supervisor are identical The arterial pressures (PA) of the controller and the supervisor may deviate by a maximum of ± 30 mmHg (in priming and rinsing only).	30 s	A03
Venous pressures of controller and supervisor are identical The venous pressures (PV) of the controller and the supervisor may deviate by a maximum of ± 30 mmHg (in priming and rinsing only).	30 s	A04
Weight values of controller and supervisor are identical The weights determined by the controller and the supervisor on the load cell may deviate by a maximum of ± 250 g (in priming and rinsing only and if plasma side is running).	30 s	A05
Temperatures of controller and supervisor are identical The temperatures determined by the controller and the supervisor may deviate by a maximum of 2.5 °C (in priming and rinsing only).	180 s	A06
BLD selftest This test is performed every 5 min during the therapy and reinfusion phase.	5 min	A07
SAD selftest The first test verifies whether the sensor detects an air signal. The second test performs a comparison between the voltage threshold and the calibration value. This test is performed every 1.5 s (=time required by an air bubble at maximum blood flow to reach the venous cannula) during priming and rinsing as well as during the therapy and reinfusion phases.	1.5 s	A08
Load cell selftest The load cell is tested every 3 s.	5 s	A09
Running internal communication Correct periodical communication is performed with the User Interface.	4 s	A10

T0 Tests by the Supervisor		
SAD clock test Time control of the SAD is checked.	0 s	A80
SAD test No or too many SAD tests are executed by the Controller or fluid is detected during test.	2 s	A90
SAD reference test Reference voltage of SAD is tested to be within limit.	1 s	A94
Running internal communication Correct periodical communication is performed with the User Interface and periodical life signal is received from Controller.	6 s 3 s	A99

Static T1 Tests by the Controller		
ROM-RAM The ROMs and RAMs of the controller are verified with a CRC test.	Selftest	
Calibration data The calibration data of the controller are verified with a CRC test.	Selftest	
Sensor ZERO test The controller analyses the following target values: <ul style="list-style-type: none"> • Arterial pressure [within +/- 20 mmHg] • Prefilter pressure [within +/- 20 mmHg] • Venous pressure [within +/- 20 mmHg] • Weight [below 50 g] • SAD in air detection • PCLD in air detection • HCLD in air detection • DAD in air detection Verification of whether the dialysate air detector (DAD), the sensor for the level monitoring of the precipitate air chamber (PCLD) and the sensor for the level monitoring of the heparin adsorber air chamber (HCLD) detect an air signal.	Selftest	A13-A20
Supervisor 24 V relay The controller checks whether the supervisor can stop all pumps by means of the 24 V relay. <ul style="list-style-type: none"> • Controller activates the blood pump with a flow rate of 100 ml/min for 5 s. • The supervisor opens the 24 V relay. The test passes when the controller detects that the blood pump is stopped.	Selftest	A21
Supervisor heating relay The controller checks whether the supervisor initiates the switching off of the heating via the heating relay. <ul style="list-style-type: none"> • The supervisor opens the heating relay. • The controller activates the heater to the maximum temperature for 20 s. The test passes when the temperature deviation is less than 1 °C.	Selftest	A22

<p>Controller alarm tone buzzer</p> <p>The test includes the successive activation of all four alarm tones.</p> <ul style="list-style-type: none"> • Power failure buzzer <ul style="list-style-type: none"> ▪ Long alarm tone ▪ The control system initiates the alarm situation of a mains failure for 2 seconds • Controller alarm buzzer <ul style="list-style-type: none"> ▪ Continuous alarm tone ▪ The control system initiates the buzzer for 2 seconds • Supervisor alarm buzzer <ul style="list-style-type: none"> ▪ Continuous alarm tone ▪ The supervisor system activates the buzzer for 2 seconds • Warning buzzer <ul style="list-style-type: none"> ▪ Three alarm tones in successive short intervals. ▪ The monitor system activates the warning buzzer for 2 seconds. No danger exists for the patient. <p>The user is responsible for checking whether the buzzers function correctly.</p>	Selftest	
---	----------	--

Static T1 Tests by the Supervisor		
<p>ROM-RAM</p> <p>The ROMs and RAMs of the supervisor are verified with a CRC test</p>	Selftest	
<p>Calibration data</p> <p>The calibration data of the supervisor are verified with a CRC test.</p>	Selftest	
<p>Sensor ZERO test</p> <p>The supervisor analyses the following set values:</p> <ul style="list-style-type: none"> • Arterial pressure [within +/- 20 mmHg] • Venous pressure [within +/- 20 mmHg] • Weight [below 100 g] • SAD in air detection 	Selftest	A95-A98
<p>Heparin pump test</p> <p>The supervisor initiates a heparin bolus and checks the uniform delivery rate of the pump by means of a light barrier. The piston guide should be engaged in the middle position!</p>	Selftest	A93
<p>Supervisor alarm tone buzzer</p> <p>The test includes the activation of the alarm tone.</p> <ul style="list-style-type: none"> • Supervisor alarm buzzer (continuous alarm tone). <p>The supervisor system activates the buzzer for 2 seconds. The user is responsible for checking whether the buzzer works correctly.</p>	Selftest	

Dynamic T1 Tests by the Controller		
<p>PPF transducer connection test</p> <p>While the precipitate filter is filled the position of the PPF transducer is tested for correctness. The connection is correct if:</p> <ul style="list-style-type: none"> - (PPF < 3 mmHg) or (PPF < -3 mmHg) as long as the plasma/buffer pump is running. 	Step 4 Priming and rinsing	A74
<p>Weight deviation by the plasma/buffer pump</p> <p>Verification after activation of step 4 of the priming and rinsing phase whether the weight decrease on the load cell corresponds to the delivery rate of the plasma/buffer pump (65 ml/min). The test starts as soon as 10 g have been delivered. For a duration of 30 s, the weight decrease must be higher than 20 g and less than 40 g, otherwise alarm A26 will be initiated and the test sequence has to be repeated. Priming cannot be completed if there is a fluid level in the precipitate filter air chamber (PCLD).</p>	Step 4 Priming and rinsing	A26
<p>HAK leakage test</p> <p>Verification in step 4 of the priming and rinsing phase whether the HAK can be closed and the connection line is inserted properly into HAK. Therefore the Controller checks during priming phase of the precipitate filter if the PPF remains under 350 mmHg after 1000 ml filling volume have been reached and HAK is closed.</p> <p>After filling the precipitate filter (step 4) and reaching the fluid level in the precipitate chamber and heparin adsorber chamber there must be a pressure of >350 mmHg on the PPF when HAK is closed. At the same time PDPA is to be >250 mmHg. If the PDPA is < 250 mmHg A33 will be initiated. Acknowledge the alarm. The test will only be repeated twice.</p>	Step 4 Priming and rinsing	A33
<p>Blood leak detector (BLD) test</p> <p>The blood leak detector is tested for its general functionality and self calibration. Self calibration failed: Functionality test failed. If the reason for the alarm cannot be fixed therapy cannot be started.</p>	Step 5 Priming and rinsing	A35 A07
<p>Deaeration of the heparin adsorber and the ultrafilter (no test)</p> <p>As soon as there is a fluid level in the heparin adsorber air chamber (HCLD) a short level regulation of precipitate and heparin adsorber air chamber takes place. Afterwards the heparin adsorber is primed until a volume of 225 ml is reached. Filtrate line and ultrafilter are deaerated. During priming of the heparin adsorber the levels cannot be set manually. In this phase balance and level regulation alarms are suppressed.</p>	Step 6 to 8 Priming and rinsing	

<p>Deaeration of the dialysis side and dialysis side tests During this phase the dialysis side is tested. The DAD is deaerated and the plate warmer is tested. Afterwards dialysis pump and ultrafiltration pump are tested. The setting up is checked for correctness at the end.</p> <p>Deaeration of the dialysis side</p> <ul style="list-style-type: none"> • Blood pump starts running with 11 ml/min in order to deaerate and prime the dialysis fluid line correct. 	Step 9 Priming and rinsing	A27 A28 A29 A30 A31 A32
<p>Plate warmer test</p> <ul style="list-style-type: none"> • During this priming phase the plate warmer is tested. Within 2 minutes a temperature of >41.5 °C at the Controller and >42 °C at the Supervisor must be measured. 		A32
<p>DAD Test</p> <ul style="list-style-type: none"> • The dialysis pump increases its speed to 200 ml/min. During this phase the DAD is tested. It must detect fluid within 20 seconds. 		A28
<p>Dialysis test</p> <ul style="list-style-type: none"> • During dialysis tests the dialysis fluid pump (DP) and the ultrafiltration pump (UFP) run with 140 ml/min. • The tests must reach the values within 160 seconds. • The function of the DP is tested by the UFP in order to get a positive PDI and to avoid a failure of the plate warmer bag. • The UFP test checks if the PDI remains stable at approx. 120 mmHg. DP flow and UFP flow should have a ratio of UFP = 0.9 DP. Regulation limits are: <ul style="list-style-type: none"> ▪ PDI > PDIBasis + 20 mmHg (= 140 mmHg), then UFP = 0.9 DP + 20 ml/min. ▪ PDI > PDIBasis - 20 mmHg (= 100 mmHg), then UFP = 0.9 DP - 20 ml/min. • A27 will be initiated in the following situation: <ul style="list-style-type: none"> ▪ PDI > 200 mmHg at the beginning of the test, UFP is standing still. ▪ PDI is not increased by 30 mmHg within 12 seconds while DP is running. ▪ PDI is not decreased by 30 mmHg within 12 seconds while UFP is running. ▪ PDI > 250 mmHg while ultrafiltration side is filled (UFP is standing still). ▪ UF side cannot be filled within 160 seconds. This can be measured by a weight change at the load cell (comparison of weight before and after priming). 		A27

<p>Leakage test of the line system The line system is tested for correct seat and leakage (leakage, leaky sensors, line ruptures) by the pressure test. The SAK is closed and all pumps are running.</p> <ul style="list-style-type: none"> • Pressure test: Within 50 seconds > 200 mmHg must be reached at the PV, PDF and PDI. • Leakage test: pressure decrease PV > 30 mmHg • Sensor test: <ul style="list-style-type: none"> ▪ High pressure PBE > 240 mmHg, PPL/PPF > 250 mmHg ▪ Sensor leaky if: PBE-PV > 30 mmHg, PDF-PV > 30 mmHg, PDI-PV > 40 mmHg, PPL < 150 mmHg, PPF < 150 mmHg. <p>Rupture of the pump segments: Rotation of the following pumps (speed):</p> <ul style="list-style-type: none"> • BP 10 ml/min., PBP 2 ml/min., DP 10 ml/min., UFP 10 ml/min. with subsequent sensor test (see point 3). 		A29 A30 A31 A29 A30 A31 A30
---	--	---



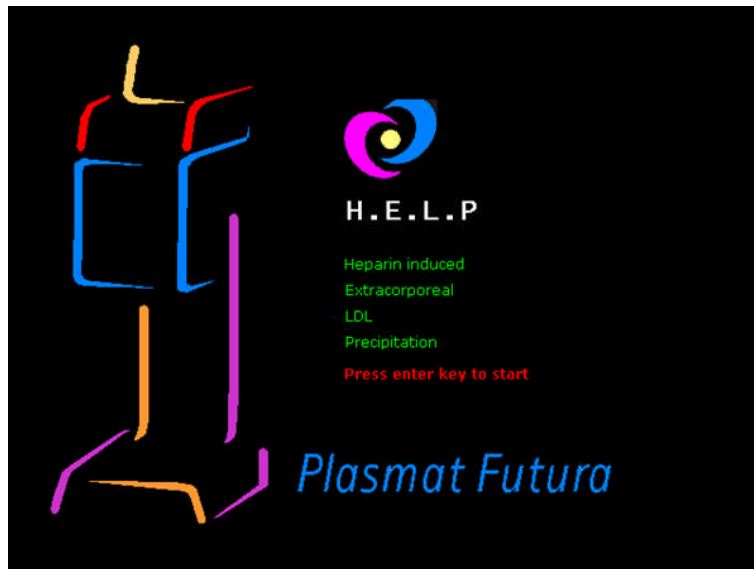

After a successful selftest, the Start screen is displayed. The preparation of solutions can now begin as well as the H.E.L.P. Plasmal® Futura set up for operation as described in chapter 3.



8.2 DYNAMIC TESTS AND CONTROLS DURING THERAPY AND REINFUSION

8.2.1 Blood Leak Detection

A blood leak alarm can be caused by blood or an air bubble in the plasma line. The reason can also be a failure in the BLD selftest. The blood leak detector is not automatically calibrated after acknowledging an alarm. After A36 advice W38 appears.

- If the advice is confirmed with  the blood leak detector is recalibrated. The sensor begins a new measurement.
- If the alarm is confirmed with  it remains suppressed for one minute. Afterwards the sensor begins a new measurement.
- If the alarm is confirmed three times with  within short time without confirming W19 with  the alarm will be repeated. If W19 is confirmed with  W20 will follow (bridging the BLD function).
- After having bridged the BLD function please contact your service technician.



Risk to the patient to due multiple manual recalibrations of the blood leak detector!

- Only recalibrate in case you are sure that the alarm is caused by a failure of the blood leak detector (defect BLD or air bubble in plasma line), or if you are sure that coloring of the plasma is caused by a failure other than a membrane rupture of the plasma filter. Multiple recalibrations during existing blood leak (red colored plasma) can lead to malfunction of the blood leak detector and therefore to uncontrolled infusion of free hemoglobin into the patient.
- Visually inspect the quality of the plasma separation.



Risk to the patient due to bridging of the blood leak detection.

- Make sure that the plasma line is inserted properly into the BLD otherwise the BLD is not able to detect any blood leakage!
- Only bridge the blood leak detection if you are sure that a malfunction of the blood leak detector caused the series of blood leak alarms.
- After bridging the blood leak detection Therapy must constantly be controlled visually by the user for hemolysis or membrane rupture of the plasma filter.

8.2.2 Connection Test in Therapy and Reinfusion

- Missing connection of the BicEL bags
 - Directly after start of Therapy a connection test of the buffer line with the acetate buffer bag is carried out. If there is no connection to the acetate buffer bag an alarm with subsequent advice box appears on the screen.

 - Directly after start of Reinfusion a connection test of the reinfusion line with the reinfusion solution is carried out. If there is no connection to the reinfusion solution an alarm with subsequent advice box appears on the screen.

8.2.3 Control of Ultrafiltration

- Control of ultrafiltration is carried out via the PDF.
- The upper limit of the balance error is reached when the corrective factor exceeds 23%. Balance alarms will follow.

8.3 ALARMS

8.3.1 Alarm Concept

An alarm situation always requires special attention and immediate processing by the user. Alarms are displayed in the alarm/note line and accompanied by an acoustic alarm tone.

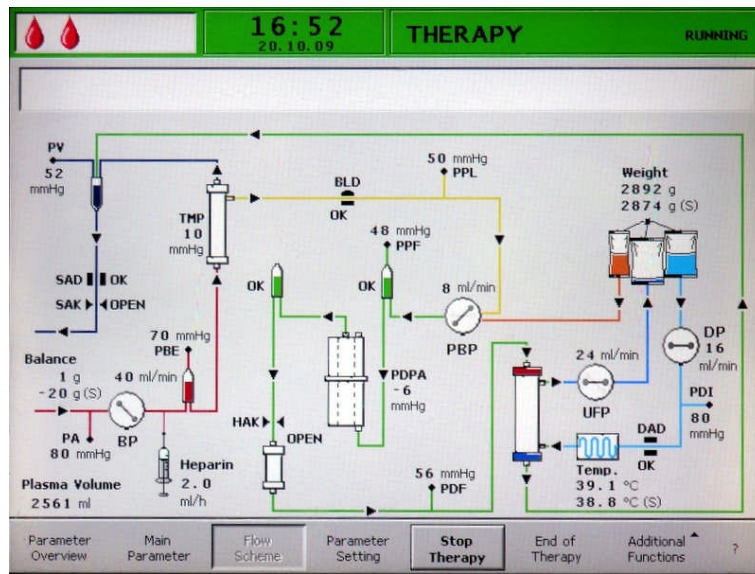

When an alarm occurs, the screen display automatically changes to the flow scheme showing the position (e.g. blinking number for pressure alarms) affected by the alarm. After correction of the alarm, the display automatically changes back to the initial screen. If the same alarm occurs again within 30 s, the initial screen display is maintained.

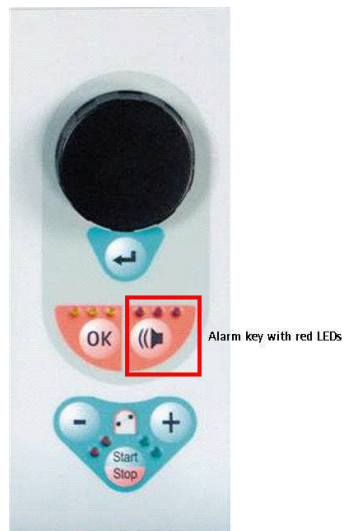

Additionally an active alarm is indicated by the red LEDs lighting above the alarm key.



An alarm is normally corrected in two steps:

- Suppression of the alarm tone by pressing the  key once.
- Elimination of the cause of the alarm and subsequent acknowledgement of the alarm by pressing the  key.



Alarms which are caused by open pump covers (A59, A60, A61, A62) are self-regulating alarms. These alarms are corrected by closing the respective pump cover.

8.3.2 List of Alarms



If an alarm cannot be corrected with the measures described, if it occurs frequently and you cannot determine its cause or if a machine defect exists, please inform technical service.

Code	Alarm text	Alarm cause	Corrective action
A01	Supervisor system not working properly	Hardware problem	<ul style="list-style-type: none"> ➤ Acknowledge the alarm (twice). If the alarm is repeated switch the machine off and on again to eliminate a possible transient failure. ➤ If the problem cannot be solved, close the treatment immediately and inform technical service.
A02	Deviation between controller and supervisor state	Hardware problem	<ul style="list-style-type: none"> ➤ Acknowledge the alarm (twice). If it is not possible switch the machine off and on again. ➤ If the problem cannot be solved, restart the machine completely or close the treatment immediately. ➤ If the problem cannot be solved with a machine restart inform technical service.
A03	Deviation of arterial pressure between controller and supervisor	Calibration or hardware problems	<ul style="list-style-type: none"> ➤ Acknowledge the alarm (twice). ➤ If the problem cannot be solved, inform technical service.
A04	Deviation of venous pressure between controller and supervisor	Calibration or hardware problems	<ul style="list-style-type: none"> ➤ Acknowledge the alarm (twice). ➤ If the problem cannot be solved, inform technical service.
A05	Deviation of weight fluid between controller and supervisor	Calibration or hardware problems	<ul style="list-style-type: none"> ➤ Acknowledge the alarm (twice). ➤ If the problem cannot be solved, inform technical service.
A06	Deviation of temperature between controller and supervisor	Calibration or hardware problems	<ul style="list-style-type: none"> ➤ Acknowledge the alarm (twice). ➤ If the problem cannot be solved, inform technical service.
A07	Blood leak detector (BLD) test failed	Hardware problem	<ul style="list-style-type: none"> ➤ Acknowledge the alarm (twice). If the alarm is repeated switch the machine off and on again. ➤ If the problem cannot be solved, stop the treatment as soon as possible while visually inspecting for a possible blood leak in the plasma line. ➤ Inform technical service.

Code	Alarm text	Alarm cause	Corrective action
A08	Safety air detector (SAD) test failed	Hardware problem	<ul style="list-style-type: none"> ➤ Acknowledge the alarm (twice). If the alarm is repeated switch the machine off and on again. ➤ If the problem cannot be solved, stop the treatment immediately taking care to visually inspect for air bubbles in the venous return line. ➤ Then inform technical service.
A09	Weight system test failed	Hardware problem	<ul style="list-style-type: none"> ➤ Acknowledge the alarm (twice). If the alarm is repeated switch the machine off and on again. ➤ If the problem cannot be solved, stop the therapy immediately then close the treatment with reinfusion. ➤ Inform technical service.
A10	User interface not communicating	Hardware problem	<ul style="list-style-type: none"> ➤ Acknowledge the alarm (twice). If the alarm is repeated switch the machine off and on again to eliminate a possible transient failure. ➤ If the problem cannot be solved, stop the treatment immediately and inform technical service.
A13	Arterial pressure (PA) not zero	Consumables already or still mounted	➤ Remove all consumables from the machine.
A14	Prefilter pressure (PBE) not zero	Consumables already or still mounted	➤ Remove all consumables from the machine.
A15	Venous pressure (PV) not zero	Consumables already or still mounted	➤ Remove all consumables from the machine.
A16	Load cell not empty or load cell error	Consumables already or still mounted	➤ Remove all consumables from the machine.
A17	Line in SAD not empty or SAD error	Consumables already or still mounted	➤ Remove all consumables from the machine.
A18	Precipitate chamber not empty or level sensor error	Consumables already or still mounted	➤ Remove all consumables from the machine.
A19	Heparin adsorber chamber not empty or level sensor error	Consumables already or still mounted	➤ Remove all consumables from the machine.
A20	Line in DAD not empty or DAD error	Consumables already or still mounted	➤ Remove all consumables from the machine.
A21	Power relay test failed	Defective hardware	➤ Switch the machine off and on again to restart the machine.
A22	Heater relay test failed	Defective hardware	➤ Switch the machine off and on again to restart the machine.

Code	Alarm text	Alarm cause	Corrective action
A26	Weight test error. Check bag, clamps, connections and pump!	It was determined with weight test that 1. the plasma/buffer pump does not deliver correctly and 2. there is a fluid level in the precipitate chamber. <ul style="list-style-type: none"> ▪ Malfunction of the plasma/buffer pump. ▪ Malfunction of the load cell. ▪ Error in refilling. 	<ul style="list-style-type: none"> ➤ Ensure for 1. that: <ul style="list-style-type: none"> ▪ The seal on the saline bag is open. ▪ The clamp on the buffer line is open. ▪ The buffer line is not kinked or clamped. ▪ The plasma/buffer pump segment is not inserted crosswise and in the correct direction. ➤ Ensure for 2. that: <ul style="list-style-type: none"> ▪ there is no fluid in the precipitate chamber and that the sensors are fluid free. ➤ After eliminating the cause of the alarm and acknowledging the alarm, the test is automatically repeated.
A27	Dial. side test failed. Check DP/UF pumps and clamps on the bag!	It was determined with the dialysate test that the dialysate pump or the ultrafiltration pump does not deliver correctly. <ul style="list-style-type: none"> ▪ Dialysate or ultrafiltration flow obstructed. 	<ul style="list-style-type: none"> ➤ Ensure that: <ul style="list-style-type: none"> ▪ The seals of the dialysate bags are open. ▪ The clamps of the dialysate/ultrafiltration lines are open. ▪ The dialysate/ultrafiltration line is not kinked or clamped. ▪ The bags are hanging motionless on the load cell. ➤ After eliminating the cause of the alarm and acknowledging the alarm, the test is automatically repeated.
A28	DAD test failed	In the priming and rinsing phase, an error occurred during the DAD check <ul style="list-style-type: none"> ▪ Malfunction of DAD. 	<ul style="list-style-type: none"> ➤ Ensure that: <ul style="list-style-type: none"> ▪ the dialysate line is inserted in the air detector for the dialysate (DAD). ▪ the clamps on the dialysate line are open. ▪ the seals of the dialysate bags are open. ▪ the connections between the dialysate bags and the dialysate line are firmly seated. ➤ After eliminating the cause of the alarm and acknowledging the alarm, the test is automatically repeated.
A29	Pressurization failed. PV, PDF, PDI < 200 mmHg. Check line in SAK!	Pressure build-up and pressure holding test failed	<ul style="list-style-type: none"> ➤ Ensure that: <ul style="list-style-type: none"> ▪ The PBE pressure transducer is screwed on correctly. ▪ The venous line was inserted in the safety air clamp (SAK). ▪ All lines were installed according to instruction. ▪ The venous pressure transducer (PV) is correctly screwed on.

Code	Alarm text	Alarm cause	Corrective action
A30	Leakage test failed. Check connections of filters and sensors!	An error occurred during the check of the safety air clamp (SAK) and the line leakage test.	<ul style="list-style-type: none"> ➤ Ensure that: <ul style="list-style-type: none"> ▪ The venous line is inserted in the safety air clamp (SAK). ▪ The connections between the lines and the filters are firmly seated. ▪ The venous pressure transducer (PV) is correctly screwed on. ➤ After eliminating the cause of the alarm and acknowledging the alarm, the test is automatically repeated.
A31	Pressure sensors failed. Check proper connection of sensors!	An error occurred during the calibration of the venous pressure (PV) and the inlet pressure on the plasma filter (PBE).	<ul style="list-style-type: none"> ➤ Ensure that: <ul style="list-style-type: none"> ▪ The pressure transducer for the PV is correctly screwed on. ▪ The pressure transducer for the PBE is correctly screwed on. ➤ After eliminating the cause of the alarm and acknowledging the alarm, the test is automatically repeated.
A32	Heater test failed	Malfunction of heater	➤ Inform technical service.
A33	HAK test failed, check insertion line?	Line not correctly inserted in HAK clamp	<ul style="list-style-type: none"> ➤ Ensure that: <ul style="list-style-type: none"> ▪ The filtrate line is inserted correctly in the HAK clamp.
A34	2 ml air infused	SAD has detected a total of > 2 ml air	<ul style="list-style-type: none"> ➤ Ensure that: <ul style="list-style-type: none"> ▪ The lines have no leaks. When leaks are found, replace the respective line. ▪ All components have been connected firmly and properly. ▪ The venous chamber is sufficiently filled. If required, fill the venous chamber manually.
A35	Blood leak detector (BLD) calibration failed	Malfunction of blood leak detector	➤ Inform technical service.
A36	Blood leakage detected	The BLD detects a blood leak or larger air bubbles in the line	<ul style="list-style-type: none"> ➤ Perform a visual inspection of the line after the plasma filter. Replace the plasma filter when a blood leak is found. ➤ If air bubbles are found, check the connections for firm seating and the lines for possible damage (see 8.5.4).

Code	Alarm text	Alarm cause	Corrective action
A37	Air in the venous line. Set PV to -50 mmHg to remove the air.	Air found in venous line	<ul style="list-style-type: none"> ➤ Clamp shut the venous line with the clamp between the plasma filter (venous outlet) and the venous chamber. ➤ Set a clamp on the reinfusion line at the connection to the venous chamber. ➤ Set the level at PV -50 mmHg (level regulation will be stopped at -100 mmHg). Observe that the pressure transducer PV is not filled up to the protector. ➤ The safety air clamp (SAK) opens automatically and the air is removed from the venous line into the venous chamber. ➤ Using the level regulation button, manually adjust the level in the venous air chamber again (PV > 0 mmHg). ➤ Open the clamp of the venous line. ➤ Open the clamp of the reinfusion line. ➤ Acknowledge the alarm. ➤ Continue treatment.
A38	Minimum arterial pressure (PA)	Arterial pressure too low	<ul style="list-style-type: none"> ➤ Ensure that: <ul style="list-style-type: none"> ▪ The arterial access is free and properly connected. ➤ If necessary, reduce the blood flow.
A39	Maximum arterial pressure (PA)	Arterial pressure too high	<ul style="list-style-type: none"> ➤ Ensure that: <ul style="list-style-type: none"> ▪ The arterial access is free and properly connected. ➤ If necessary, increase the blood flow.
A40	Minimum prefilter pressure (PBE)	Prefilter pressure too low	<ul style="list-style-type: none"> ➤ Ensure that: <ul style="list-style-type: none"> ▪ The venous access is free and properly connected.
A41	Maximum prefilter pressure (PBE)	Prefilter pressure too high	<ul style="list-style-type: none"> ➤ Ensure that: <ul style="list-style-type: none"> ▪ The venous access is free and properly connected. ▪ The venous line is not kinked or clamped.
A42	Minimum venous pressure (PV)	Venous pressure too low	<ul style="list-style-type: none"> ➤ Ensure that: <ul style="list-style-type: none"> ▪ The arterial access is free and properly connected. ▪ The buffer line is not kinked or clamped.
A43	Maximum venous pressure (PV)	Venous pressure too high	<ul style="list-style-type: none"> ➤ Ensure that: <ul style="list-style-type: none"> ▪ The venous access is free and properly connected. ▪ The venous line is not kinked or clamped.

Code	Alarm text	Alarm cause	Corrective action
A44	Minimum plasma pressure (PPL)	Plasma pressure too low, plasma flow too high	<ul style="list-style-type: none"> ➤ Ensure that: <ul style="list-style-type: none"> ▪ The blood flow/plasma flow ratio is approximately 3:1. ▪ The plasma filter is unobstructed and functional. Replace the plasma filter if it is obstructed (see 8.5.4). ➤ If necessary, reduce the plasma flow.
A45	Maximum plasma pressure (PPL)	Plasma pressure too high Defective PPL pressure transducer Defective pressure sensor	<ul style="list-style-type: none"> ➤ Check the plasma line and replace it if you find a defect.
A46	Low PPF. Check high chamber level, protector or buffer bag empty.	Precipitate filter pressure too low	<ul style="list-style-type: none"> ➤ Ensure that: <ul style="list-style-type: none"> ▪ The clamp on the buffer line is open. ▪ The seal of the acetate buffer bag is open. ▪ The acetate buffer bag is not empty. ▪ The level in the PPF chamber is not high and especially the PPF protector is not wet.
A47	Maximum precipitate filter pressure (PPF)	Precipitate filter pressure too high Defective level detector	<ul style="list-style-type: none"> ➤ Ensure that: <ul style="list-style-type: none"> ▪ The lines after the precipitate chamber are not kinked or clamped. ▪ The pump segment of the ultrafiltration pump is correctly inserted. ▪ The precipitate filter is not saturated. If the precipitate filter is saturated, a rise of the PDPA occurs in parallel. Replace the filter in this case. ▪ The heparin adsorber is permeable. If this is not the case, replace the heparin adsorber. ▪ The dialyzer is permeable. If this is not the case, replace the dialyzer. ➤ If necessary, reduce the plasma flow or the reinfusion flow.
A48	Minimum dialysis filter pressure (PDF)	Dialyzer pressure too low (< -50 mmHg) Plasma flow too low	<ul style="list-style-type: none"> ➤ Ensure that: <ul style="list-style-type: none"> ▪ There is no dialyzer leakage. If this is the case, replace the dialyzer (see 8.5.7). ➤ If necessary, increase the plasma flow.

Code	Alarm text	Alarm cause	Corrective action
A49	Maximum dialysis filter pressure (PDF)	Dialyzer pressure too high	<ul style="list-style-type: none"> ➤ Ensure that: <ul style="list-style-type: none"> ▪ The lines after the dialyzer are not kinked or clamped. ▪ The pump segment is correctly inserted in the ultrafiltration pump. ▪ The dialysate drain line is not kinked or clamped. ▪ The clamps on the dialysate drain are open.
A50	Minimum dialysate inlet pressure (PDI)	Dialysate inlet pressure too low Defective dialysate pump	<ul style="list-style-type: none"> ➤ Ensure that: <ul style="list-style-type: none"> ▪ The clamps on the dialysate line are open. ▪ The seals of the dialysate bags are open.
A51	Maximum dialysate inlet pressure (PDI)	Dialysate inlet pressure too high	<ul style="list-style-type: none"> ➤ Ensure that: <ul style="list-style-type: none"> ▪ The warming bag is inserted correctly and without kinks. ▪ The line between the dialyzer and the plate warmer is not kinked or clamped.
A53	Maximum transmembrane pressure (TMP)	Transmembrane pressure too high Defective pressure sensors for PV, PPL or PBE	<ul style="list-style-type: none"> ➤ Ensure that: <ul style="list-style-type: none"> ▪ The venous pressure (PV) is not too high. ▪ The plasma prefilter pressure (PBE) is not too high. ▪ The plasma filter is not clogged. If this is the case, replace the filter (see 8.5.4). ▪ The blood flow/plasma flow ratio is approximately 3:1. ▪ The pressure transducers for PV, PPL and PPE are correctly seated and are dry. ➤ If necessary, reduce the blood flow. ➤ If necessary, reduce the plasma flow.
A54	Maximum precipitate-adsorber drop pressure (PDPA max)	Pressure drop between precipitate filter and adsorber too high	<ul style="list-style-type: none"> ➤ Ensure that: <ul style="list-style-type: none"> ▪ The precipitate filter is not saturated. If this is the case, replace the filter (see 8.5.5). ▪ The lines between the precipitate filter and the adsorber are not kinked or clamped.
A55	Low precipitate chamber level. Check air bubbles in chamber and locking.	PPF chamber level sensor detects air	<ul style="list-style-type: none"> ➤ Ensure that: <ul style="list-style-type: none"> ▪ The buffer line is not kinked or clamped. ▪ The seal of the acetate buffer bag is open. ▪ The acetate buffer bag is not empty. ▪ The PPF chamber is positioned and the level sensor is locked properly. ▪ No air bubble is attached to the inner chamber wall.

Code	Alarm text	Alarm cause	Corrective action
A56	Fluid level in heparin adsorber chamber too low.	HCLD detects air Defect of automatic level adjustment	➤ Check whether the precipitate filter is saturated. If this is the case, replace the filter (see 8.5.5).
A57	Air in dialysate line	In the therapy phase, DAD detects air	➤ Ensure that: <ul style="list-style-type: none"> ▪ The dialysate bags are full. ▪ The clamps of the dialysate lines are open. ▪ The seals of the dialysate bags are open. ➤ The dialysate line is not damaged and the connections to the bags are tight. Replace the line if it is damaged.
A58	Stop of blood pump too long! Clotting danger!	Blood pump stop > 120 s	➤ Start the blood pump to eliminate the alarm and to acknowledge the error.
A59	Blood pump cover open	Blood pump cover open, magnetic sensor of pump defective	➤ Close the pump cover.
A60	Plasma/buffer pump cover open	Plasma/buffer pump cover open Magnetic sensor of pump defective	➤ Close the pump cover.
A61	UF pump cover open	Ultrafiltration pump cover open Magnetic sensor of pump defective	➤ Close the pump cover.
A62	Dialysate pump cover open	Cover of dialysate pump open Magnetic sensor of pump defective	➤ Close the pump cover.
A63	Blood pump speed error	Wrong speed of blood pump Defective blood pump	➤ Ensure that: <ul style="list-style-type: none"> ▪ The pump segment is correctly inserted in the blood pump.
A64	Plasma/buffer pump speed error	Wrong speed of plasma/buffer pumps Pump defective	➤ Ensure that: <ul style="list-style-type: none"> ▪ The pump segment is correctly inserted in the plasma/buffer pump.
A65	UF pump speed error	Wrong speed of ultrafiltration pump Ultrafiltration pump defective	➤ Ensure that: <ul style="list-style-type: none"> ▪ The pump segment is correctly inserted in the ultrafiltration pump.
A66	Dialysate pump speed error	Wrong speed of dialysate pump Defective dialysate pump	➤ Ensure that: <ul style="list-style-type: none"> ▪ The pump segment is correctly inserted in the dialysate pump.
A67	Maximum dialysate temperature	Dialysate too warm (> 41.5°C for > 10 s) Defective heating element	➤ Close the cover of the plate warmer.

Code	Alarm text	Alarm cause	Corrective action
A68	Excessive weight change, check bags and lines!	Weight variation between 50 and 200 g for more than 5 s or weight variation > 200 g	<ul style="list-style-type: none"> ➤ Ensure that: <ul style="list-style-type: none"> ▪ The bags are hanging motionless on the load cell. ▪ The lines are hanging free and do not pull on the bags on the load cell. ▪ The bags do not move too much. ➤ This alarm is also activated if a bag has been removed from or added to the load cell. In this case, please correct the error.
A69	Balance error	Balance error > 200 g Defect of plasma/buffer pump, of ultrafiltration pump or of load cell	<ul style="list-style-type: none"> ➤ Ensure that: <ul style="list-style-type: none"> ▪ The seals of the saline bags and of the dialysate bags are open. ▪ The lines are not kinked or clamped. ▪ The clamps on the buffer line and on the dialysate line are open. ▪ The dialysate line is inserted into the support on the load cell. ▪ The pump segments are correctly inserted.
A70	Weight too high or load cell empty	Weight > 24500 g or weight < 50 g	<ul style="list-style-type: none"> ➤ Reduce the weight on the load cell. ➤ Hang the bags back on to the load cell.
A72	Acet. buffer bag connection error. Open clamps on bag!	System detects too low delivery rate of the plasma buffer pump due to too low PPF	<ul style="list-style-type: none"> ➤ Check for correct connection between acetate bag and buffer line. ➤ Ensure that the seals and clamps are open and check that the buffer line is free and not kinked.
A73	High PPF chamber level	PPF chamber level is too high, PPF protector is wet. No PPF pressure increase in case of closed HAK clamp.	<ul style="list-style-type: none"> ➤ Ensure that: <ul style="list-style-type: none"> ▪ The PPF chamber level is not too high and PPF protector is not wet. ▪ The PPF protector is connected properly. ▪ The PPF chamber is positioned and the level sensor is locked properly. ▪ No air bubble is attached to the inner chamber wall.
A74	PPF protector is not connected	No pressure change on PPF.	<ul style="list-style-type: none"> ➤ Ensure that: <ul style="list-style-type: none"> ▪ The PPF protector is connected properly.
A75	Solution connection problem. Check lines, clamps and bags!	After changing from the priming and rinsing to the therapy phase or from the therapy to the reinfusion phase, the load cell detects no weight reduction.	<ul style="list-style-type: none"> ➤ Ensure that: <ul style="list-style-type: none"> ▪ The seal of the saline/buffer bag is open. ▪ The clamp on the saline/buffer line is open. ▪ The saline/buffer line is not kinked or clamped. ▪ The bags are hanging motionless on the load cell.

Code	Alarm text	Alarm cause	Corrective action
A76	Reinfusion volume wrong. Check dial./UF lines and clamps.	Balance error in plasma reinfusion phase.	<ul style="list-style-type: none"> ➤ Ensure that the pump segments (DP and UFP) are inserted properly. ➤ Ensure that the lines are not kinked. ➤ Ensure that the clamps connecting the dialysate line/the ultrafiltration line with the drainage bags are open.
A77	Reinfusion connection error. Open both clamps on IV pole bag!	Pressure test at the beginning of reinfusion	<ul style="list-style-type: none"> ➤ Ensure that the plasma reinfusion line is connected to the upper rinsing bag. ➤ Check that the clamps and seals are open and that the plasma reinfusion line is not kinked.



Alarms marked with (S) (A80 – A104) are alarms which are generated by the supervisor. If these alarms are active, it is possible that the controller does not operate correctly. If an alarm cannot be corrected with the actions suggested below or if it occurs frequently, inform technical service.

A80	(S) SAD clock error. Switch off and on!	It was not possible to synchronize the SAD status between the controller and the supervisor.	➤ Switch the machine off and on.
A81	(S) Blood pump speed error	Wrong speed of blood pump Defective blood pump	➤ Ensure that: <ul style="list-style-type: none"> ▪ The pump segment is correctly inserted in the blood pump.
A82	(S) Plasma/buffer pump speed error	Wrong speed of plasma/buffer pump Defective plasma/buffer pump	➤ Ensure that: <ul style="list-style-type: none"> ▪ The pump segment is correctly inserted in the plasma/buffer pump.
A83	(S) UF pump speed error	Wrong speed of ultrafiltration pump Ultrafiltration pump defective	➤ Ensure that: <ul style="list-style-type: none"> ▪ The pump segment is correctly inserted in the ultrafiltration pump.
A84	(S) Dialysate pump speed error	Wrong speed of dialysate pump Defective dialysate pump	➤ Ensure that: <ul style="list-style-type: none"> ▪ The pump segment is correctly inserted in the dialysate pump.
A85	Heparin pump problem. Check pump or syringe.	Syringe empty or current position of heparin pump wrong	➤ Ensure that: <ul style="list-style-type: none"> ▪ The syringe is not empty. ▪ The lock on the heparin pump support is closed. ▪ The guide of the heparin pump is no longer in the maximum upper position.
A86	(S) Blood pump stop for too long!	Blood pump stop > 150 sec	➤ Start the blood pump to eliminate the alarm and to acknowledge the error.
A87	(S) Maximum dialysate temperature	Temperature of dialysate too high (> 42°C for > 20 s) Defective heating element	➤ Inform technical service.
A88	(S) Venous pressure (PV) out of limits	Venous pressure too high or too low	➤ Ensure that: <ul style="list-style-type: none"> ▪ The venous access is free and properly connected. ▪ The venous line is not kinked, clamped or damaged.
A89	(S) Arterial pressure out of limits	Arterial pressure too high or too low	➤ Ensure that: <ul style="list-style-type: none"> ▪ The arterial access is free and properly connected. ▪ The arterial line is not kinked or clamped. ➤ If required, reduce the blood flow if the arterial pressure (PA) is too low. ➤ If required, increase the blood flow if the arterial pressure is too high.

A90	(S) Safety air detector (SAD) test failed!	Calibration or hardware problems	➤ Switch the machine off and on again.
A91	(S) Air in venous line	Air found in venous line	<ul style="list-style-type: none"> ➤ Clamp the venous line with the clamp between the plasma filter (venous outlet) and the venous chamber. ➤ Connect a syringe to the venous chamber and manually suck out the air from the venous line. ➤ Open the clamp on the venous line. ➤ Acknowledge the alarm. ➤ Continue the treatment. ➤ Using the level adjustment button of the venous air chamber, readjust the level in the venous air chamber.
A92	(S) 3 ml air infused	SAD has detected a total of > 3 ml air	<ul style="list-style-type: none"> ➤ Ensure that: <ul style="list-style-type: none"> ▪ The lines have no leaks. When leaks are found, replace the respective line. ▪ All components have been connected firmly and properly. ▪ The venous chamber is sufficiently filled. If required, fill the venous chamber manually.
A93	(S) Heparin pump test failed!	Heparin pump slider in false position during the test	➤ The heparin pump slider may not be fully inserted. Place the heparin pump slider into a different position.
A94	(S) SAD reference test error!	Calibration or hardware problems	➤ Switch the machine off and on again.
A95	(S) Line in SAD not empty or SAD error	Consumables already or still mounted	➤ Remove all consumables from the machine.
A96	(S) Load cell not empty or load cell error	Consumables already or still mounted	➤ Remove all consumables from the machine.
A97	(S) Venous pressure (PV) not zero!	Consumables already or still mounted	➤ Remove all consumables from the machine.
A98	(S) Arterial pressure (PA) not zero!	Consumables already or still mounted	➤ Remove all consumables from the machine.
A99	(S) Control system not working properly!	Erroneous controller or user interface function	<ul style="list-style-type: none"> ➤ Acknowledge the alarm (twice). If it is not possible switch the machine off and on again to eliminate a possible transient failure. ➤ If the problem cannot be solved, close the treatment immediately and inform technical service.
A100	(S) SAD clock test error. Switch off and on!	Erroneous SAD clock function	<ul style="list-style-type: none"> ➤ Switch the machine off and on. ➤ If alarm remains after power off, call service.

A103	(S) Balance error	Balance error > 500 g Defect of plasma/buffer pump, of ultrafiltration pump or of load cell	<ul style="list-style-type: none"> ➤ Ensure that: <ul style="list-style-type: none"> ▪ The seals of the saline bags and of the dialysate bags are open. ▪ The lines are not kinked or clamped. ▪ The clamps on the buffer line and on the dialysate line are open. ▪ The dialysate line is inserted into the support on the load cell. ▪ The pump segments are correctly inserted.
A104	(S) Plasma volume error	Count error of plasma treated volume	<ul style="list-style-type: none"> ➤ Ensure that: <ul style="list-style-type: none"> ▪ The plasma lines are not kinked or clamped. ▪ The pump segments are correctly inserted.
A105	(S) Reinfusion volume wrong (balance)	Balance error during plasma reinfusion	<ul style="list-style-type: none"> ➤ Ensure that the pump segments (DP and UFP) are inserted properly. ➤ Ensure that the lines are not kinked. ➤ Ensure that the clamps connecting the dialysate line/the ultrafiltration line with the drainage bags are open.

8.4 WARNINGS

8.4.1 Warning Concept

Warnings are given when:

- The user should perform a certain action.
- A certain state must be pointed out to the user.

Warnings are always accompanied by acoustic warning tones.

Warnings which serve to point out a situation are displayed in the Alarm/Note field.

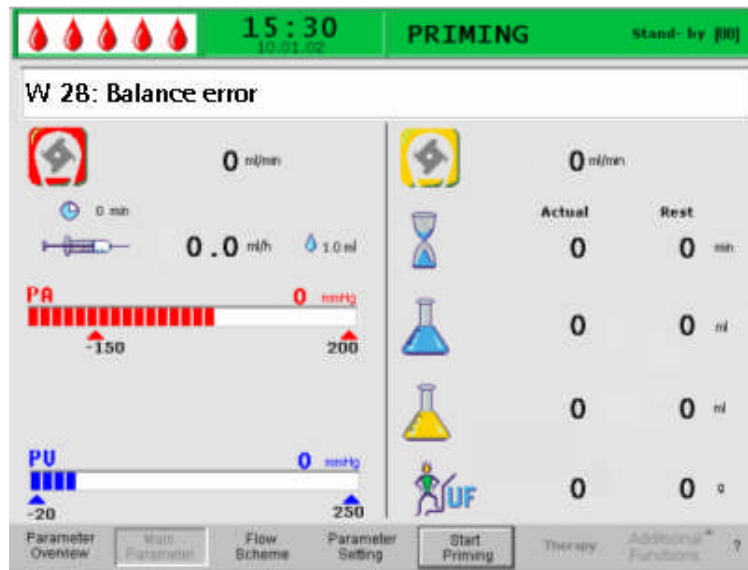

Warnings requiring an action are displayed in a Warning window, they must be acknowledged with the **OK** key (<Press 'OK' to proceed>) to continue in the respective phase.

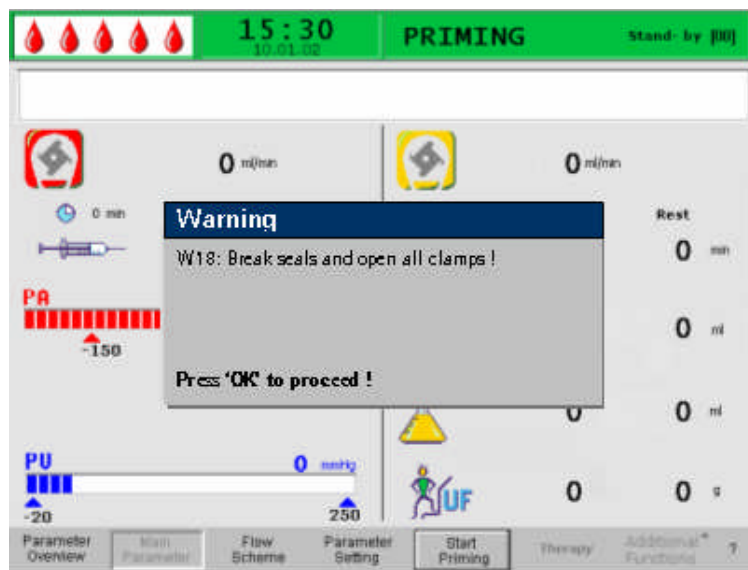

This kind of warning is also indicated by the yellow LEDs lighting above the  key.

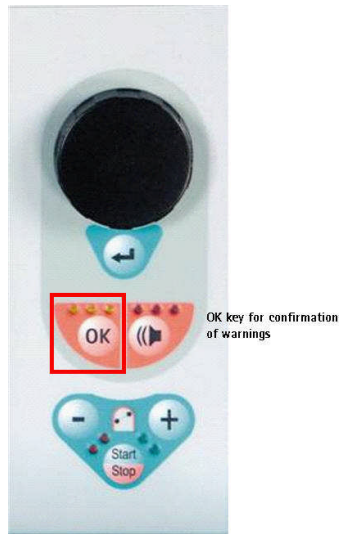















8.4.2 List of Warnings

i

M = Display in the message box



T = Display in the alarm/note line







Code	Warning Text	Reason for Warning	Corrective Action	
W01	Plasma pump starts after pressurization blood side	Indication that the arterial line is filled and the filling phase is continuing.		T
W03	Press 'OK' to confirm safety data	Safety query when parameters with safety relevance have been changed	➤ The changed parameters have safety relevance. Check the setting thoroughly and confirm with the  key.	M
W04	Turn dialyzer (blue side down)!	In the filling phase, the next handling step is indicated.	➤ Turn over the dialyzer and confirm with the  key	M
W05	Therapy interrupted for too long	Therapy interrupted for more than 5 minutes	➤ Continue the therapy. ➤ Select the <Start Therapy>  key.	T
W06	Therapy completed	The end of the therapy is indicated.	➤ Press the  key to change to the reinfusion phase.	M
W08	Reinfusion stop for too long	Reinfusion interrupted for more than 5 minutes	➤ Continue the reinfusion. ➤ Select the <Start Reinfusion>  key.	T
W09	Check lines and bags	Deviation of total weight on the load cell in bypass	➤ Check the bags and lines and perform the necessary corrections. ➤ Press the  key to continue.	M
W11	1) Connect reinfusion and buffer lines to saline solution 2) Clamp plasma line at out of plasma filter 3) Turn plasma and precipitate filters 4) Turn heparin adsorber	Information for preparing the plasma reinfusion	➤ Follow the instructions on the monitor and then press the  key to continue.	M
W12	Plasma reinfusion completed! For Blood Reinfusion Stop Blood Pump (do not press 'OK') or for further Plasma Reinfusion Press 'OK' to proceed!	Plasma reinfusion completed, information concerning the preparation for blood reinfusion	➤ Follow the instructions on the monitor to change to the blood reinfusion or press the  key to continue plasma reinfusion.	M

Code	Warning Text	Reason for Warning	Corrective Action	
W14	Rinsing completed. For further rinsing set new value!	The minimum rinsing volume of 2400 ml has been reached.	<ul style="list-style-type: none"> ➤ Confirm the warning with the  key. ➤ Change to the therapy mode when you consider the rinsing volume to be sufficient. ➤ Increase the rinsing volume (see chapter 4) and therefore extend the rinsing phase, if required (e.g. when replacing a filter during the rinsing phase). 	M
W15	Connect buffer, check if seal and clamp are open!	Confirmation before the start of the therapy.	<ul style="list-style-type: none"> ➤ Check the positions given on the monitor and confirm with the  key to continue. 	M
W16	Press 'OK' to return to menu selection!	Information for quitting the screen when adjusting the parameters	<ul style="list-style-type: none"> ➤ Press the  key to return from <Parameter Setting> to the menu bar. 	T
W17	Blood reinfusion completed	Information that blood reinfusion is completed.	<ul style="list-style-type: none"> ➤ Remove the venous line from the patient and terminate the treatment. ➤ Increase the blood reinfusion volume (see chapter 6) and continue reinfusion if you consider it necessary. 	T
W18	Break seals and open all clamps!	Confirmation at the start of priming and rinsing	<ul style="list-style-type: none"> ➤ Follow the instructions on the monitor and confirm with the  key to continue. 	M
W19	Press 'OK' to exclude BLD alarms!	Is offered as an option after three BLD alarms	<ul style="list-style-type: none"> ➤ Press the  key to override the BLD alarm. 	M
W20	BLD alarms excluded	Information when the BLD alarm has been overridden by accepting the W19 option.		T
W21	1) Connect art. line to saline solution bag 2) Connect reinfusion line to venous chamber	Confirmation before the blood reinfusion.	<ul style="list-style-type: none"> ➤ Check the positions given on the monitor and confirm with the  key to continue. 	M
W22	No change on arterial pressure (PA). Check PA protector!	The machine does not register a change of the PA while the blood pump is running.	<ul style="list-style-type: none"> ➤ Ensure that: <ul style="list-style-type: none"> ▪ The arterial pressure transducer (PA) is correctly connected and dry. ➤ If the error cannot be corrected, the pressure transducer or the pressure sensor is defective. 	T
W23	Minimum dialysate inlet pressure (PDI min)	Information when the inlet pressure of the dialysate is too low.	<ul style="list-style-type: none"> ➤ Ensure that: <ul style="list-style-type: none"> ▪ The clamps on the dialysate line are open. ➤ Increase the plasma flow. 	T

Code	Warning Text	Reason for Warning	Corrective Action	
W24	Balance error > 300 g Check lines and bags!	Balancing error of more than 300 g	<ul style="list-style-type: none"> ➤ Ensure that: <ul style="list-style-type: none"> ▪ Bags and lines are hanging free. ▪ There is no leakage on bags and lines. ▪ The bags are hanging motionless. 	M
W25	Balance error > 400 g END OF THERAPY IS RECOMMENDED	Balancing error of more than 400 g	<ul style="list-style-type: none"> ➤ Ensure that: <ul style="list-style-type: none"> ▪ Bags and lines are hanging free. ▪ There is no leakage on bags and lines. ▪ The bags are hanging motionless. ➤ If none of the errors listed above exist, stop the therapy or perform a balance reset. 	M

 WARNING	<p>Risk to patient due to impact on the patient's fluid balance.</p> <ul style="list-style-type: none"> ➤ Perform the balance reset only when you are sure that the balancing error was triggered by a leakage of the dialysis and/or waste bags and does not concern the patient! ➤ If you are not able to detect the root cause: stop therapy and call a technician!
---	--

W26	Reinfusion volume wrong	The weight variation on load cell differs of [150g] from reinfused plasma in plasma reinfusion.	<ul style="list-style-type: none"> ➤ Ensure that: <ul style="list-style-type: none"> ▪ Buffer line is connected to the saline solution. ▪ Bags and lines are hanging free. 	T
W28	Balance error	Balancing error of > 200 g	<ul style="list-style-type: none"> ➤ Ensure that: <ul style="list-style-type: none"> ▪ Bags and lines are hanging free. ▪ There is no leakage on bags and lines. ▪ The bags are hanging motionless. 	T
W29	Are you sure to reset patient balance?	Safety query during balance reset	<ul style="list-style-type: none"> ➤ Confirm with the  key when you are sure that you wish to perform the balance reset. 	M
W30	Control system not communicating	Controller problem	<ul style="list-style-type: none"> ➤ Switch the machine off and on again. If the problem cannot be solved, inform technical service. 	T
W31	Supervisor system not communicating	Supervisor problem	<ul style="list-style-type: none"> ➤ Switch the machine off and on again. If the problem cannot be solved, inform technical service. 	T
W32	Activate therapy mode?	Prompt for changing to therapy mode	<ul style="list-style-type: none"> ➤ Confirm with the  key. 	M
W33	Heparin bolus	Safety query before administering the set heparin bolus	<ul style="list-style-type: none"> ➤ Press the  key to administer the heparin bolus. ➤ If you do not wish to administer the heparin bolus, wait 5 s for the Warning window to disappear. 	M

W34	High UF correction! UF-filter SMC? If not, check bags for leakage.	The correction value of the UF is higher than 23%. The reason can be a leakage of the bags. When using the Ultrafilter SMC, the correction value during the preparation phase is higher.	<ul style="list-style-type: none"> ➤ Check the bags on the lead cell for leakages and correct connection. ➤ This message can be ignored if an Ultrafilter SMC is used and leakage can be excluded; i. e. the message is caused by the system. 	
W35	Activate reinfusion?	Prompt for changing to reinfusion mode	<ul style="list-style-type: none"> ➤ Press the  key to change to the reinfusion phase. 	M
W36	Are you sure to start a new therapy? Return to this therapy is not possible.	Information before returning to the Start screen	<ul style="list-style-type: none"> ➤ Press the  key if you wish to return to the Start screen. 	M
W37	Selftests completed. Check characters, key LEDs, then press Enter!	Confirmation of the successfully performed initial selftest	<ul style="list-style-type: none"> ➤ Select 'END' softkey and press . 	T
W38	Blood leak detected. Visible blood in plasma line: reduce plasma flow or change plasma filter and acknowledge alarm! In any other cases (to recalibrate BLD): Press 'OK' to proceed!	Blood in the plasma line or blood leak detector (BLD) defect	<ul style="list-style-type: none"> ➤ Check the plasma filter for rupture and change it if necessary. ➤ When confirming with  the blood leak detector will be recalibrated. Blood leak measurements will be done using the new calibration level. ➤ Blood leak measurement restarts when confirming alarm A36 with . ➤ After the BLD alarm occurred three times within short time it is possible to mute the BLD function (W19/W20). 	
W39	Power fail eliminated. Check lines, filters and parameter setting, then restart! Press 'OK' to proceed! Are you sure? Press 'OK' to proceed!	Information after a power failure	<ul style="list-style-type: none"> ➤ Press the  key after verification of the required positions to continue therapy. 	M
W41	Open plasma clamp and close venous clamp!	Information in blood reinfusion	<ul style="list-style-type: none"> ➤ Follow the instructions on the screen. 	M
W42	Set Plasma Flow is too low. Increase Blood or Plasma Flow.	Information that the required Plasma Flow is too low (< 2 ml/min)	<ul style="list-style-type: none"> ➤ Increase the blood flow or increase the plasma flow to increase the plasma flow rate. 	T

W43	Attention! Precipitate filter rupture possible! Precipitate chamber level, PPF protector and connection or check air bubbles in chamber and chamber locking!	PPF chamber level is too high, PPF protector is wet. No PPF pressure increase in case of closed HAK clamp. (This warning appears together with alarm A73)	<ul style="list-style-type: none"> ➤ Ensure that: <ul style="list-style-type: none"> ▪ The PPF chamber level is not too high and PPF protector is not wet. ▪ The PPF protector is connected properly. ▪ The PPF chamber is positioned and the level sensor is locked properly. ▪ No air bubble is attached to the inner chamber wall. ➤ Then press the  key after examination to continue therapy. 	M
W44	Patient Balance too high or Plasma Flow too low. Please adjust.	The required patient balance cannot be reached in the remaining therapy time. Balance error might occur later during the course of the treatment.	<ul style="list-style-type: none"> ➤ Reduce the patient balance value or increase the plasma volume value or increase plasma flow value. 	T
W45	Dialysate bags nearly empty. Change bags if necessary.	Not enough dialysate for the selected treatment. Selected ratio plasma/dialysate requires more fluid than available on the load system.	<ul style="list-style-type: none"> ➤ Prepare further bag with dialysate and change the bags. ➤ Change full drainage bag against empty one if necessary. ➤ Check ratio plasma/dialysate. 	M
W49	High UF correction for long time. Check lines and clamps!	Balance error	<ul style="list-style-type: none"> ➤ Ensure that the pump segments (DP and UFP) are inserted properly. ➤ Ensure that the lines are not kinked. ➤ Ensure that the clamps connecting the dialysate line/the ultrafiltration line with the drainage bags are open. 	
W50	Buffer line flow disturbance or weight error. 1) Check bag on load cell and seal broken. 2) Check buffer line connected and clamp opened. 3) Check plasma pump segments.	Load cell test error	<ul style="list-style-type: none"> ➤ Follow the instructions on the screen. 	
W51	Remove air from SAD by venous level regulation! 1) Close both venous and plasma lines at PV chamber. 2) Increase PV level and stop at PV < -50 mmHg. 3) Open both lines at PV and acknowledge alarm. 4) Decrease PV level and stop at PV 0 mmHg.	SAD detected air in the venous line	<ul style="list-style-type: none"> ➤ Follow the instructions on the screen. 	

W52	Plasma pump is too slow. Check and decrease PPL threshold.	Plasma/buffer pump runs constantly with 2 ml/min.	<ul style="list-style-type: none"> ➤ Adapt the PPL threshold to the current PPL. ➤ Increase the plasma flow by increasing the blood pump speed and/or the plasma pump speed. 	
W53	Reinfusion volume error > 300 g. Check dialysate and UF line clamps opened!	Balance error > 300 g	<ul style="list-style-type: none"> ➤ Ensure that <ul style="list-style-type: none"> ▪ bags and lines hang free ▪ there are not leaks in bags/lines ▪ the bags hang motionless 	
W54	Reinfusion error > 400 g. End of reinfusion recommended!	Balance error > 400 g	<ul style="list-style-type: none"> ➤ Ensure that <ul style="list-style-type: none"> ▪ bags and lines hang free ▪ there are not leaks in bags/lines ▪ the bags hang motionless ➤ If none of the above mentioned errors exist, stop therapy and make a balance reset. 	
W55	Plasma reinfusion connection error! 1) Check reinfusion line connected to NaCl pole bag. 2) Check buffer line connected to NaCl bag. 3) Check clamps of both lines opened!	Pressure test error at the beginning of reinfusion	<ul style="list-style-type: none"> ➤ Ensure that <ul style="list-style-type: none"> ▪ the plasma reinfusion line is connected with the upper rinsing bag. ▪ clamps and seals are open and plasma reinfusion line is not kinked. 	
W56	Weight of bags too low on the load cell. 1) Check that the proper kit is applied. 2) Check acetate buffer/all dialysate bags hanging.	Wrong weight on load cell	<ul style="list-style-type: none"> ➤ Check the selected treatment volume and the number of BicEL bags on the load cell. ➤ Add further bag(s) if necessary. ➤ Is the (empty) rinsing bag changed against the acetate buffer bag? ➤ Check the correct position of the bags on the load cell. 	
W57	Plasma volume > 4 l. Change buffer bag and check dialysate bags.	Information plasma volume > 4 l.	<ul style="list-style-type: none"> ➤ Change empty buffer bag against new one. ➤ Check number of BicEL bags. ➤ Check drainage bags and remove full bags if necessary (upper limit of weight on the load cell 25 kg). 	
W58	Acetate buffer bag connection error. 1) Check buffer bag is hung on the load cell! 2) Check buffer line connected to the buffer bag. 3) Check clamps on the line and bag opened.	System detected too low delivery rate of the plasma buffer pump due to too low PPF.	<ul style="list-style-type: none"> ➤ Check for correct connection of acetate and buffer line. ➤ Ensure that clamps and seals are open and check if buffer line is free and not kinked. 	

W59	Acetate buffer bag connection test. DP/UFP pumps are stopped.	System tests correct connection of acetate buffer bag at the beginning of therapy. Both dialysis pumps are standing still during the test.	➤ No corrective action required!
W60	Reinfusion bag connection test. DP/PBP pumps are stopped.	System tests correct connection of the NaCl bag at the beginning of reinfusion. Both dialysis pumps are standing still during the test.	➤ No corrective action required!

 CAUTION	Risk to patient due to impact on the patient's fluid balance. ➤ Perform the balance reset only when you are sure that the balancing error was triggered by a leakage of the dialysis and/or waste bags and does not concern the patient! ➤ If you are not able to detect the root cause: stop therapy and call a technician!
--	--

	Note that the data of the currently performed therapy are deleted when you return to the Start screen.
---	--

8.5 PROBLEM CORRECTION



8.5.1 Balance Reset

Balance error > 200 g

For a balance error > 200 g, the alarm <A69: Balance error!> and the warning <W28: Balance error> are displayed.

➤ Check whether:

- The bags are hanging correctly on the load cell.
- All seals and clamps are open.
- All lines are free from kinks.



➤ Acknowledge the alarm with  and  after you have eliminated the cause of the error.

The warning <W28: Balance error> is displayed until the balance error has been compensated.

Balance error > 300 g

If the balance error remains and exceeds a value of 300 g, the alarm <A69: Balance error!> is initiated and the warning <W24: Balance error > 300 g, check lines and bags!> displayed.

➤ Check the system as described above.

➤ Acknowledge the alarm and the warning with  and  after you have eliminated the cause of the error.

The warning <W28: Balance error> is displayed until the balance error has been compensated.

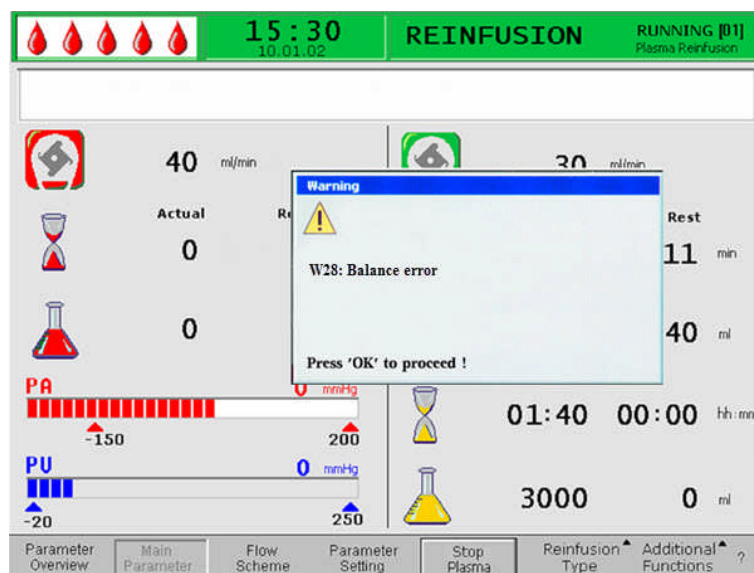



Balance error > 400 g

If it was not possible to correct the balance error with the measures described above and it exceeds a value of 400 g, the alarm <A69: Balance error!> is initiated again and the warning <W25: Balance error > 400 g END OF THERAPY IS RECOMMENDED> is displayed.

The end of therapy is recommended to exclude a balance error in the fluid balance of the patient.

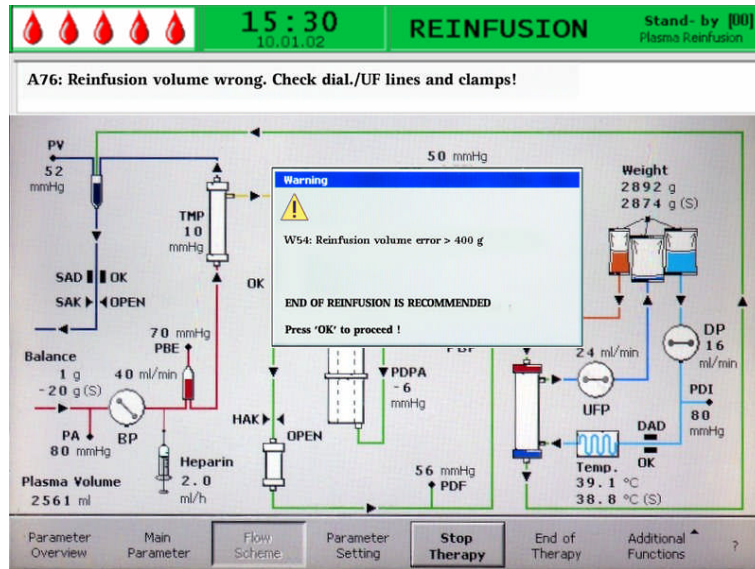
Terminate the therapy as described in section 5.4.1.







WARNING

Risk to patient due to impact on the patient's fluid balance.

- Perform the balance reset only when you are sure that the balancing error was triggered by a leakage of the dialysis and/or waste bags and does not concern the patient!
- If you are not able to detect the root cause: stop therapy and call a technician!

Starting with a balance error > 400 g, the <Balance Reset> menu item under <Additional Functions> can be selected by turning the knob and pressing the  key. Warning <W29: Are you sure to reset Patient Balance?> is displayed.

➤ Press  to proceed.

During a balance reset, the load cell is newly tared. The data of the balance reset are saved and shown in the Parameter Overview. Every reset performed in the course of the therapy is saved and the values are summated.

		16:51 20.10.09		THERAPY		RUNNING	
Therapy Time	04:34	hh:mm	PA	80	mmHg	MIN	MAX
Plasma Volume	2554	ml	PBE	68	mmHg	10	150
Patient Balance	1	g	PV	52	mmHg	32	92
▶ Blood Flow	40	ml/min	PPL	50	mmHg	-10	200
▶ Plasma Flow	8	ml/min	TMP	10	mmHg		50
Heparin Flow	2.0	ml/h	PPF	48	mmHg	-20	450
Heparin Bolus	1.0	ml	PDF	54	mmHg	-50	350
Autostop Heparin	0	min	PDPA	-6	mmHg		150
Tot. Hep. Infused	9.2	ml	PDI	80	mmHg	-50	450
Temperature	39.0	°C	PPL Threshold		mmHg	20	
Rinsing Volume	0	ml	Ratio Dialysate/Plasma			2	
			Reset Balance Volume			0	g

8.5.2 Deaeration of the Heparin Adsorber

If the fluid level in the heparin adsorber drops during the therapy, it can be refilled.



Permanently too low fluid levels in the heparin adsorber can result in a decreased adsorption efficiency. There may be a risk of heparin overdose in the patient.

- Carefully open the lateral heparin adsorber port during operation. Wait until the fluid level has increased and close the port again.

8.5.3 Changing the Solution Bags

Change as a result of a defective bag

- Select the <Stop Therapy> function to go to the bypass mode (blood pump is turning, plasma-side pumps stand still).
- Attach a clamp to the bag to be exchanged and close the clamp on the feed line.
- Exchange the defective bag for a new bag.
- Break the seal of the new bag.
- Open the clamp of the feed line again.
- Confirm the warning <W09: Check lines and bags> by pressing the  key.
- Continue the treatment by selecting the <Start Therapy> function.

Change at a treatment volume > 4000 ml



At a treatment volume > 4010 ml, the H.E.L.P. Plasmal[®] Futura automatically switches to bypass. The warning <W57: Plasma vol. > 4 l. Change buffer bag and check dialysate bags!> is displayed. Remove the full drain bags and replace them.

- Attach a clamp to the feeding buffer line.
- Remove the empty acetate buffer bag and replace it by a new prepared acetate buffer bag.
- Open the seal of the new acetate buffer bag.
- Reopen the clamp on the buffer line again.

- Check also whether sufficient dialysate is available and replace dialysate bags if necessary.
- Confirm the change by pressing the  key.
- Continue the therapy by selecting the <Start Therapy> function.

Change of the dialysate bags if they are nearly empty

If the ratio dialysate/plasma is $> 1:2$ and the dialysate bags are nearly empty, the H.E.L.P. Plasmac® Futura automatically switches to bypass. The warning <W45: Dialysate bags nearly empty. Change bags if necessary.> is displayed.

- a) Exchange dialysate bags if more dialysate solution is required:
 - Attach a clamp to the feeding dialysate line.
 - Remove the empty dialysate bag and replace it by a newly prepared dialysate bag.
 - Open the seal of the new dialysate bag.
 - Reopen the clamp on the dialysate line again.
 - Repeat for the other dialysate bags if necessary.
 - Remove the full drain bags and replace them.
 - Confirm the subsequent message box <W09: Check lines and bags!> by pressing the  key.
- b) The remaining amount of dialysate is sufficient for termination of the treatment:
 - Confirm by pressing the  key.

8.5.4 Changing the Plasma Filter

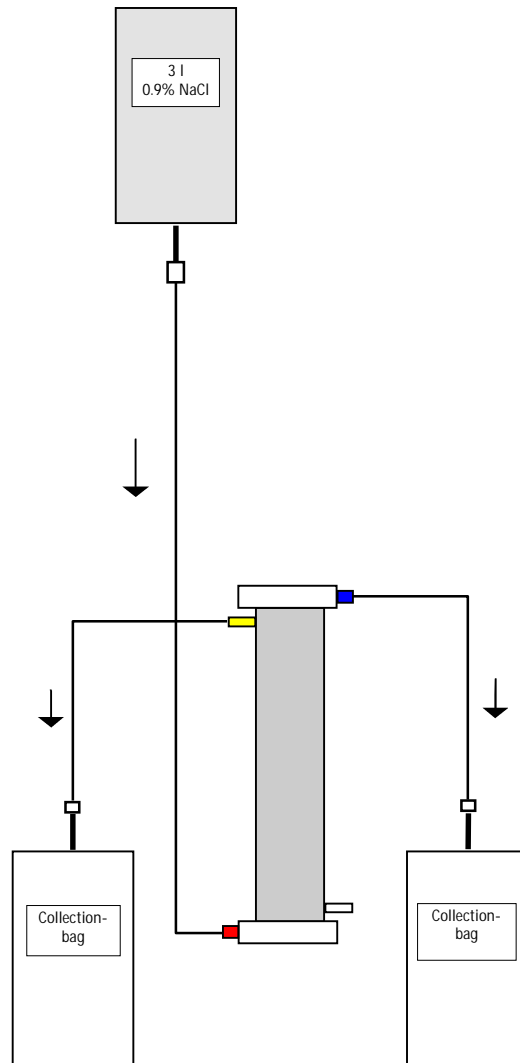



Material	Article number
Haemoselect L 0.5	7061007C
2 x collection bags	7210929
3 l H.E.L.P. 0.9 % NaCl- solution	4107
3 collection lines	7210934
7500 IU heparin	

- Mix 7500 IU heparin into the H.E.L.P. 0.9% NaCl solution.
- Attach a connection line to the NaCl solution, fill the line and connect it with the blood-side inlet of the filter.
- Attach the remaining connection lines and the collection bags as shown in the figure with the plasma and blood side of the filter and clamp shut the line on the plasma side.
- Allow the rinse solution to flow by means of gravity into the blood-side collection bag.
- Hold the filter so that it is filled from the bottom to the top and thoroughly vented in the process.
- Open the plasma-side line when approximately half of the rinse solution has flown into the blood-side collection bag and clamp shut the blood-side line. Continue to rinse.
- Clamp shut all connection lines when the remaining rinse solution has flown through (be careful that no air enters the filter!) and remove the bags.
- Stop the blood pump, clamp shut the arterial and the venous plasma line, remove the old filter and connect it with the new plasma filter in the correct orientation. Close the old filter with the remaining connection lines.
- Reopen the blood and plasma lines and start the blood pump.

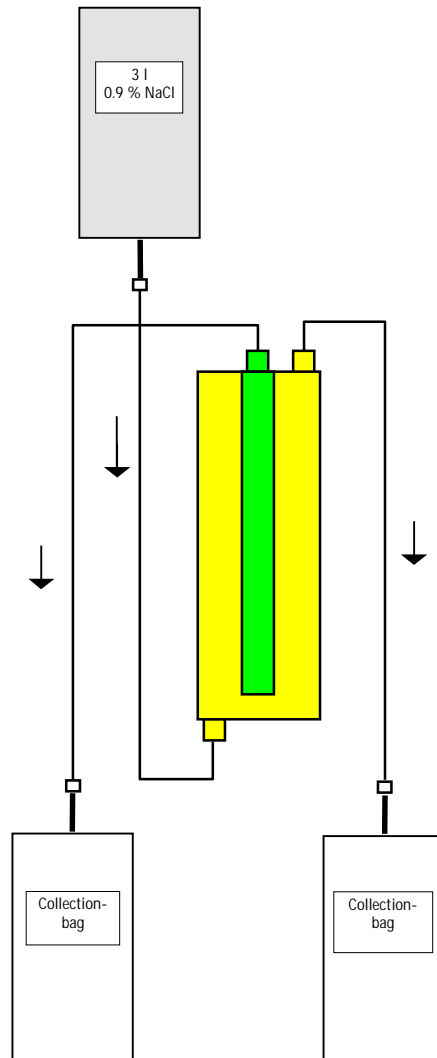
8.5.5 Changing the H.E.L.P. Precipitate Filter





Material	Article number
H.E.L.P. precipitate filter	7210931
2 x collection bags	7210929
3 l 0.9% H.E.L.P. NaCl solution	4107
3 connection lines	7210934

- Attach a connection line with the NaCl solution, fill the line and connect it with the bottom, precipitate-side filter opening.
- Attach the remaining connection lines and the collection bags as shown in the figure with the upper precipitate and filtrate-side opening of the filter and clamp shut the line on the filtrate side.
- Allow the rinse solution to flow by means of gravity into the precipitate-side collection bag.
- Hold the filter so that it is filled from the bottom to the top and thoroughly vented in the process.
- Open the filtrate-side line when approximately half of the rinse solution has flown into the precipitate-side collection bag and clamp the precipitate-side line. Continue to rinse.
- Clamp shut all connection lines when the remaining rinse solution has flown through (be careful that no air enters the filter!) and remove the bags.
- Switch the machine to bypass mode by selecting <Stop Priming> or <Stop Therapy> in the menu bar and confirm with .
- Clamp shut the filtrate line and the circulation line on both sides of the old precipitate filter, remove the old filter and then connect the new filter in the correct orientation with the lines. Close the old filter with the remaining connection lines.
- Reopen the circulation and filtrate lines and continue the interrupted phase by selecting <Start Priming> or <Start Therapy> and confirm with .
- Retain the exchanged filter until the end of therapy, providing it has no leak. Connect it again in the reinfusion phase and then return the plasma. Increase the reinfusion volume accordingly.

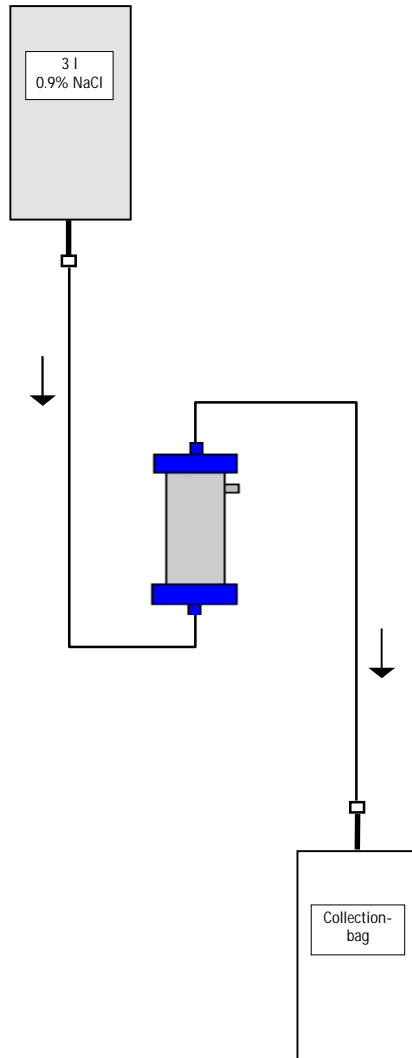
8.5.6 Changing the H.E.L.P. Heparin Adsorber



Material	Article number
H.E.L.P. heparin adsorber 400	7211089
1 x collection bag	7210929
3 l H.E.L.P. 0.9% NaCl solution	4107
2 connection lines	7210934

- Attach a connection line with the NaCl solution, fill the line and connect it with the inlet side of the heparin adsorber.
- Attach the second connection line and the collection bag as shown in the figure with outlet side of the heparin adsorber.
- Allow the rinse solution to flow by means of gravity into the collection bag.
- Hold the adsorber so that it is filled from the bottom to the top and thoroughly vented in the process.
- Clamp shut all connection lines when the remaining rinse solution has flown through (be careful that no air enters the filter!) and remove the bags.
- Switch the machine to bypass mode by selecting <Stop Priming> or <Stop Therapy> in the menu bar and confirm with .
- Clamp shut the filtrate and the connection line on the adsorber, remove the old adsorber and connect the new adsorber in the correct orientation with the filtrate and the connection line (observe the flow direction!). Connect the old adsorber with the connection lines on rinse solution and collection bag.
- Reopen the filtrate and connection lines and continue the interrupted phase by selecting <Start Priming> or <Start Therapy> and confirm with .



CAUTION

Perform the filling and rinsing of the heparin adsorber considering the flow direction shown by the red arrow at the adsorber's label.



A false flow direction and an upside-down positioning of the heparin adsorber during rinsing and treatment will cause a loss of heparin binding capacity.

- Don't rinse the saline solution to fast into the heparin adsorber to ensure a complete deaeration of the capillaries to avoid remaining air. Air residues within the capillaries will reduce the active surface and therefore decrease the heparin binding capacity.

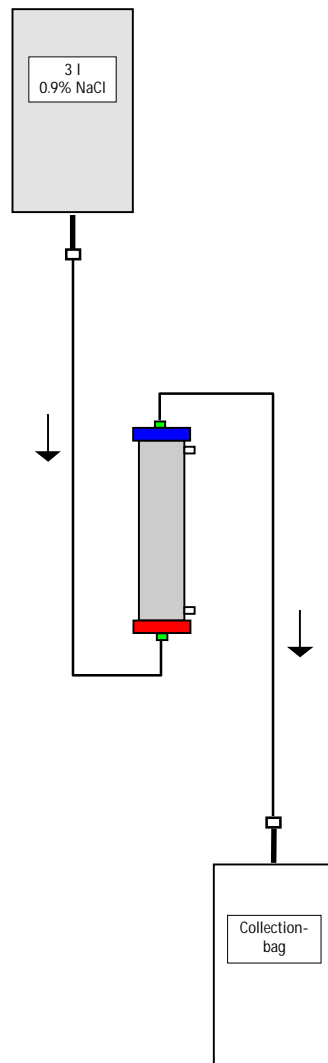
8.5.7 Changing the H.E.L.P. Ultrafilter



Material	Article number
H.E.L.P. Ultrafilter HIPS 20	7211101
1 x collection bag	7210929
3 l H.E.L.P. 0.9 % NaCl solution	4107
2 connection lines	7210934

- Attach a connection line with the NaCl solution, fill the line and connect it with the red, plasma-side filter opening.
- Attach the second connection line and the collection bag as shown in the figure with the blue, plasma-side filter opening.
- Hold the filter so that it is filled from the bottom to the top and thoroughly vented in the process.
- Clamp shut all connection lines when approximately 1 liter rinse solution has flown through (be careful that no air enters the filter!) and remove the bags.
- Switch the machine to bypass mode by selecting <Stop Priming> or <Stop Therapy> in the menu bar and confirm with .
- Clamp shut the connection and reinfusion line leading to the dialyzer, remove the old filter and connect the new filter in the correct orientation to the connection and reinfusion line. Connect the old filter with the connection lines to rinse solution and collection bag.
- Plug the Hansen connectors from the old to the new filter (hold old filter horizontally!). Observe the color marking. Insert the new filter with the blue end down into the holder.
- Fill the dialysate side of the filter by manually turning the dialysate pump.
- Reopen the connection and reinfusion lines and continue the interrupted phase by selecting <Start Priming> or <Start Therapy> and confirm with .

9	Technical Information	3
9.1	TRANSPORT	3
9.1.1	Wheeling	3
9.1.2	Carrying	4
9.2	OPERATING CONDITIONS	5
9.2.1	Installation Site	5
9.2.2	Initial Commissioning	5
9.2.3	Service and Maintenance	6
9.2.4	Disposables, Consumables and Accessories/Replacement Parts	6
9.2.5	Cleaning and Disinfection	6
9.3	GENERAL TECHNICAL DATA	7
9.3.1	Recommended Safe Distances	8
9.4	TECHNICAL DATA – COMPONENTS	8
9.4.1	Relevant Pressures	9
9.4.2	Limits of Adjustable Parameters	11
9.4.3	Extracorporeal Blood Circuit	12
9.4.4	Plasma Circuit	15
9.4.5	Dialyzing Circuit	17
9.4.6	Weight System	19
9.5	WARRANTY AND LIABILITY	20
9.5.1	Manufacturer Responsibility	20
9.5.2	Warranty and Liability	20

9 Technical Information

9.1 TRANSPORT

9.1.1 Wheeling



Risk of damage if H.E.L.P. Plasmal[®] Futura is tilted by > 5°!

- Have 2 or more persons at hand for transporting the machine on stairs and inclined areas.
- Do not tilt the H.E.L.P. Plasmal[®] Futura by more than 5°.

- Press the green brake release button in order to release the brakes.
- Wheel the H.E.L.P. Plasmal[®] Futura machine.
- Press the red brake locking button in order to apply the brakes.



9.1.2 Carrying

For carrying, the H.E.L.P. Plasmal® Futura can be held at the base, at the handles at the rear panel and at the protrusion at the front of the machine, as shown in the illustration below.

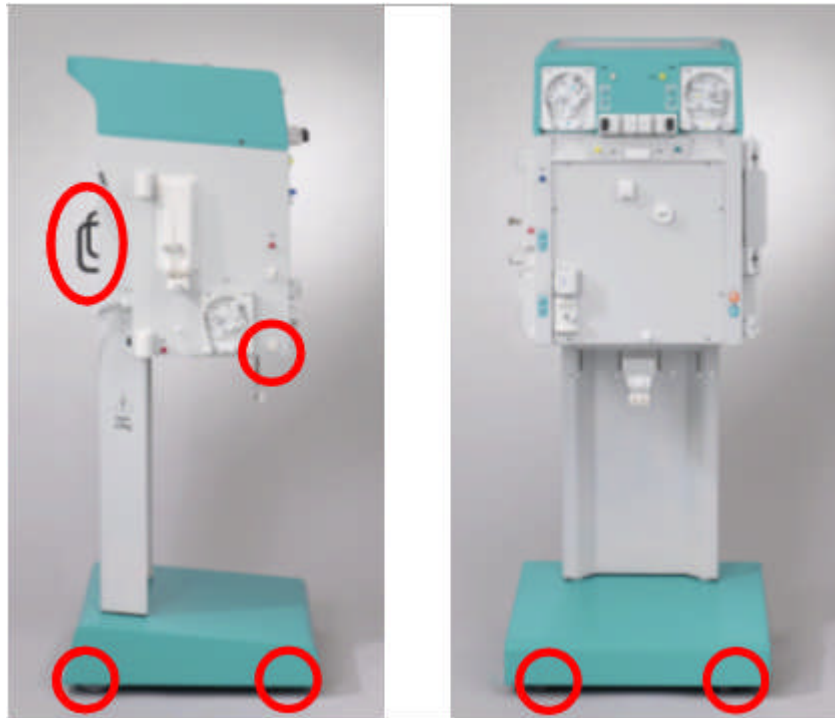

Risk of damage due to incorrect transportation (wrong holding points)!
➤ Do not hold machine on monitor, on the green top of the housing, or on infusion pole when transporting.

9.2 OPERATING CONDITIONS



The H.E.L.P. Plasmal® Futura may be operated only by trained specialist personnel. The instructions in the Instructions for Use for the machine, the disposables and consumables and the intended use must be followed.

9.2.1 Installation Site



Installation must be done only by qualified and adequately trained staff.

Ambient conditions

Observe information about ambient conditions, see chapter 9.3.

Electrical connection

The existing mains voltage must correspond with the voltage specified on the type plate. The electrical installation of the room where the machine is installed must comply with the relevant regulations (VDE 01017/VDE 0100 or IEC provisions). National guidelines specific to each country must be taken into account. If in doubt, consult your in-house technician.



The H.E.L.P. Plasmal® Futura may be operated only when connected to grounding outlets which have been installed according to the regulations. Do not use an adapter or extension cord on the main cable.



No equipment emitting electromagnetic radiation (e.g. mobile telephones) may be switched on or operated in the vicinity of an operating H.E.L.P. Plasmal® Futura.

9.2.2 Initial Commissioning

Installation and initial commissioning of the H.E.L.P. Plasmal® Futura are performed by service personnel who has been authorized by the manufacturer. Before the initial commissioning of the machine, check whether it is complete and undamaged.



If damage is found which endangers the safe operation, the machine may not be put into operation. Inform the responsible customer service. Do not switch the machine on until it has reached room temperature. Do not operate the machine in an environment where danger of explosion exists.

9.2.3 Service and Maintenance



Repairs and maintenance may be performed only by personnel authorized and trained by the manufacturer.

No special maintenance by the user is required.

The Technical Safety Inspection is to be performed every twelve months based on the Service Manual and the Instructions for Use, subject to technical changes, and to be documented.

The maintenance of the calibration sensors (load cell, temperature, pressures, blood leak detector, SAD etc.) must be performed in accordance with the specifications of the Service Manual and the respective working instructions.

If the exchanging of fuses is required, only the fuses specified by the manufacturer may be used (see Service Manual).

9.2.4 Disposables, Consumables and Accessories/Replacement Parts

The machine may be used only in combination with the H.E.L.P. apheresis treatment system.

When using the approved single-usage articles, consumables and accessories, observe the instructions for use of the respective components.

Dispose of the single-usage articles required for the treatment according to the local regulations.

Use only accessories and replacement parts whose suitability with respect to technical safety has been established and certified by an inspection authority. This verification must be carried out by an inspection authority who is authorized to inspect the ready-for-use machine.

9.2.5 Cleaning and Disinfection

All modules of the H.E.L.P. Plasmate[®] Futura and the screen may be cleaned with ethanol-containing ($\leq 70\%$) or isopropano-containing ($\leq 60\%$) surface disinfectants. Please observe the instruction for use of the respective manufacturer

9.3 GENERAL TECHNICAL DATA

Machine dimensions	Height	1330 mm
	Width	500 mm
	Depth	520 mm
Weight		55 kg
Electrical connection	Rated voltage	110 – 240 V~
	Overvoltage category	II
	Rated frequency	50/60 Hz
	FI circuit breaker	30 mA
	Class of protection	1, Type B, IP 21



The rated voltage must be identical with the voltage specified on the type plate (e.g. 230 V AC, 50/60 Hz).

Power input	Rated current	3.5 A max.
Classification	Type IIb according to Directive 93/42 EWG	
Leakage currents	Ground leakage current	< 500 µA
	Patient leakage current	< 100 µA



The allowed leakage currents may increase when several machines are connected.

Operating conditions	Operation temperature	+15 ÷ +35 °C
	Rel. humidity	30 – 90 %
	Atmospheric pressure	700 – 1060 mbar
	Height	0-3000 m above sea level
	Pollution degree classification	3
Storage conditions	Storage temperature	-20 ÷ +55 °C
	Rel. humidity	10 – 90 %
	Atmospheric pressure	700 – 1060 mbar
Potential equalization	Connection according to DIN 42801 (EN 60601-1)	
Interface	RS 485 interface for the connection of an external PC by the technical service or for therapy data collection and/or monitoring (option, information on request)	



The external PC must comply with the IEC 90950 standard (or equivalent standards/directives).

Electromagnetic compatibility	According to EN 60601-1-2 (IEC 60601-1-2)
Housing material	Corrosion-resistant aluminum Plastics (polyurethane Baydur)

9.3.1 Recommended Safe Distances

Recommended safe distances between portable or mobile HF telecommunication devices and H.E.L.P. Plasmal® Futura			
The H.E.L.P. Plasmal® Futura is for the use in ambient conditions with controlled High Frequency disturbance variables. The user can avoid electromagnetic disturbances by keeping the distance between H.E.L.P. Plasmal® Futura and HF telecommunication devices, following the values in the table below, in dependency to the output power of those devices.			
Nominal output power P of transmitter in Watt [W]	Safe distance d depending on transmitter frequency in Meter [m]		
	150 kHz to 80 MHz $d = 1.2\sqrt{P}$	80 MHz to 800 MHz $d = 1.2\sqrt{P}$	800 MHz to 2.5 GHz $d = 2.3\sqrt{P}$
0.01	0.12	0.12	0.23
0.1	0.37	0.37	0.74
1	1.2	1.2	2.3
10	3.7	3.7	7.4
100	12	12	23
For transmitters with other output power ratings the recommended safe distance d in Meter can be calculated with the above formulas. Heed the max. output power in accordance to the manufacturers information, to use the right formula from above. REMARK 1: For 80 MHz and 800 MHz use the higher frequency range. REMARK 2: This guideline may not be practicable in some cases. The propagation of electromagnetic quantity is influenced by absorption and reflection of buildings, equipment and humans			

Find more information about EMC, radio disturbance and IEC 60601-1-2 in the service manual or contact the manufacturer.

9.4 TECHNICAL DATA – COMPONENTS

Definition: Acoustic alarm interval is the time period after which an acknowledged alarm is repeated if the cause of the alarm is still present.

Pressure working ranges are defined for normal hematocrit, blood flow rate 60 – 120 ml/min, and plasma flow rate 20 – 35 ml/min.

9.4.1 Relevant Pressures

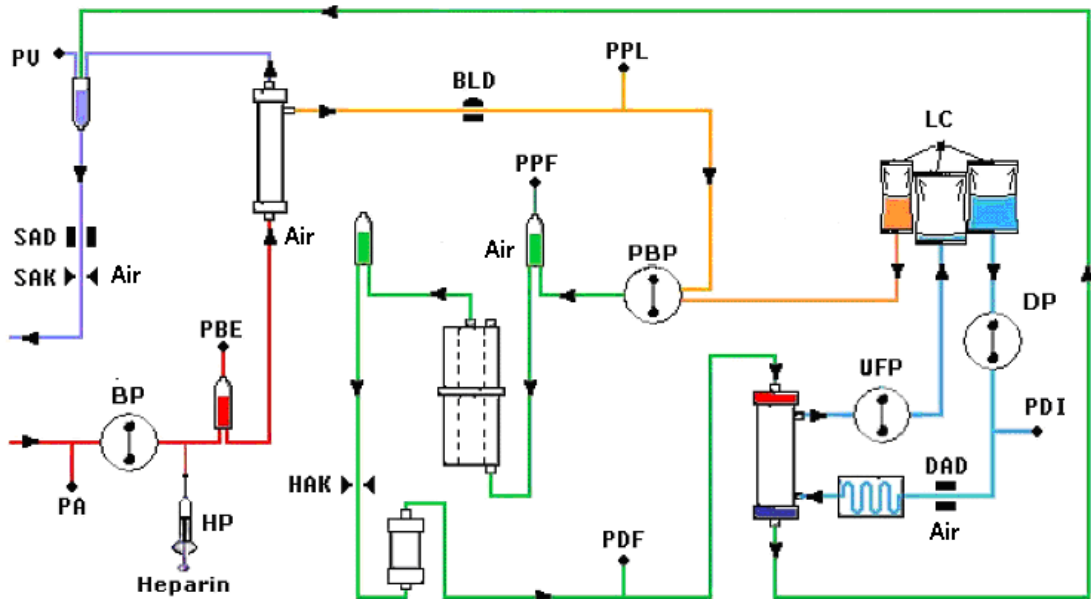

PA Arterial pressure
PBE Arterial prefilter pressure

After the blood pump is started and adapted and the automatic level adjustment of the arterial air chamber is activated, the lower and upper PBE limits are set within ten seconds in the therapy and reinfusion phase. The momentary acquired pressure (PBE Ref) serves as reference for the calculation of the alarm window.

Lower limit:
 $PBE_{min} = (PBE_{Ref} - 40) \text{ mmHg}$
 Upper limit:
 $PBE_{max} = (PBE_{Ref} + 80) \text{ mmHg}$

The lower limit PBE min can be a minimum of -100 mmHg.
 The upper limit PBE max can be a maximum of +250 mmHg.

TMP Transmembrane pressure

The TMP is calculated as follows:

$$TMP = (PBE + PV) / 2 - PPL$$

The alarm limits can be set in 10 mmHg steps between 20 and 200 mmHg. The default setting is 70 mmHg.

PPL Plasma pressure
 PPF Precipitate filter pressure
 PDPA Precipitate filter/adsorber pressure drop

The PDPA is calculated as follows:

$$PDPA = PPF - PDF$$

PDF Dialyzer pressure

PDI Dialysate inlet pressure
PV Venous pressure

During therapy and reinfusion phase, 10 sec after start of blood pump or plasma pump, and after change of the blood flow, or after the manual level regulation of the venous or PBE chamber, respectively, the lower and upper PV limits are automatically adjusted. The momentary acquired venous pressure (PV Ref) serves as mean value for the calculation of the alarm window.

Lower limit:

$PV \text{ min} = (PV \text{ Ref} - \text{MinW}) \text{ mmHg}$, when $PV \text{ Ref} > \text{MinW}$

$PV \text{ min} = 0 \text{ mmHg}$, when $5 \leq PV \text{ Ref} \leq \text{MinW}$

$PV \text{ min} = -10 \text{ mmHg}$, when $PV \text{ Ref} < 5$

MinW = Minimum PV window
(default value = 20 mmHg)

Upper limit:

$PV \text{ max} = (PV \text{ Ref} + \text{MaxW}) \text{ mmHg}$



MaxW = Maximum PV window
(default value = 40 mmHg)



9.4.2 Limits of Adjustable Parameters

Parameter	Default	min	max	Step sequence	Unit
Blood flow	40	10	150	5	ml/min
Plasma flow	20	10	40	1	% Blood flow
Plasma reinfusion volume	400	400	1000	50	ml
Blood reinfusion volume	300	100	600	50	ml
Reinfusion flow	30	10	50	5	ml/min
Ratio dialysate/plasma	2	1	4	1	
Rinsing volume	2400	2400	20.000	100	ml
Plasma volume	3000	100	6000	50	ml
Patient balance	0	-600	0	50	g
Temperature	39	34	40	0.5	°C
Heparin flow	2	0	10	0.1	ml/h
Heparin bolus	1	0	10	0.5	ml
Autostop heparin	0	0	60	5	min
PA min	-150	-350	80	10	mmHg
PA max	100	0	200	10	mmHg
Min PV window	20	10	40	5	mmHg
Max PV window	40	20	100	5	mmHg
PPL min	-10	-20	10	1	mmHg
PPL threshold	20	-20 (1)	120	5	mmHg
TMP max	70	20	200	10	mmHg
PPF min	-20	-50	50	5	mmHg
PDF min	-50	-50	0	5	mmHg
PDF max	350	10	450	10	mmHg
PDPA max	350	50	350	10	mmHg

(1) Default PPL threshold (min): -10 mmHg



9.4.3 Extracorporeal Blood Circuit

<p>Blood pump (BP)</p> 	<p>Peristaltic roller pump with motor switch-off when the pump cover is open.</p> <p>Delivery rate 10 ÷ 150 ml/min Delivery rate tolerance < ± 10 % Working pressure range -140 ÷ +500 mmHg</p> <p>Protection system Pump status and rate is monitored via a rotation detector.</p> <p>Alarm override: Not possible during the therapy</p> <p>Acoustic alarm interval: 120 seconds</p>
<p>Arterial pressure (PA)</p>	<p>Electronically measured by a pressure sensor and digitally displayed</p> <p>Measurement range: - 500 ÷ +500 mmHg Allowed tolerance ± 10 mmHg Working range: -60 ÷ +10 mmHg</p> <p>During Therapy: Default alarm limits: -150 ÷ +100 mmHg Adjustable in parameter setting</p> <p>Protection system: Double channel pressure monitoring with sensor test during preparation phase.</p> <p>Alarm override: Not possible during the therapy</p> <p>Acoustic alarm interval: 120 seconds</p>
<p>Prefilter pressure (PBE)</p> 	<p>Electronically measured by a pressure sensor and digitally displayed</p> <p>Measurement range: - 500 ÷ +500 mmHg Allowed tolerance ± 10 mmHg Working range: +90 ÷ +140 mmHg</p> <p>During Therapy: Alarm limits: -100 ÷ +250 mmHg Default alarm window: Automatic control Lower limit: Reference value -60 mmHg Upper limit: Reference value +80 mmHg</p> <p>Protection system: Sensor test during preparation phase.</p> <p>Alarm override: Not possible during the therapy</p> <p>Acoustic alarm interval: 120 seconds</p>

<p>Venous pressure (PV)</p>	<p>Electronically measured by a pressure sensor and digitally displayed</p> <p>Measurement range: -500 ÷ +500 mmHg Allowed tolerance: ± 10 mmHg Working range: +20 ÷ +50 mmHg</p> <p>During therapy: Alarm limits 0 (-10) ÷ +250 mmHg Default alarm window: Automatic control Lower limit: Reference value -20 mmHg Upper limit: Reference value +40 mmHg Parameter adjustable</p> <p>The window limiting values are set 10 seconds after reaching the set blood flow. The reference value slowly follows the systematic pressure variation.</p> <p>Protection system: Double channel pressure monitoring with sensor test during preparation phase.</p> <p>Alarm override: The absolute alarm limits cannot be overridden. The alarm window can be overridden during Blood Flow change/stop, Therapy start or PV level regulation till the re-stabilization of PV pressure (10 s).</p> <p>Acoustic alarm interval: 120 seconds</p>
<p>Safety air detector (SAD)</p> 	<p>Ultrasonic sensor on the venous line below the venous air chamber.</p> <p>Sensitivity: 0.1 ml air bolus or 2.0 ml air*</p> <p>* Calculated integral volume of any air in the form of micro-bubbles, micro-foam or the dropping of the air level in the venous line below the sensor. It is decreased continuously by a natural air removal rate.</p> <p>Protection system: Double channel air monitoring with sensor test during preparation phase and automatic, cyclic test during therapy.</p> <p>Alarm override: The alarm cannot be overridden during the therapy.</p> <p>Acoustic alarm interval: 120 seconds</p>
<p>Safety clamp (SAK)</p> 	<p>Electromagnetic clamp behind the safety air detector to close the venous return line.</p> <p>It is closed in case of a blood side alarm (e.g. by air detection).</p> <p>Protection system: Double channel activation with actuator test during preparation phase.</p>



<p>Heparin pump (HP)</p> 	<p>Syringe pump (calibrated to Perfusor syringe 30 ml Omnifix®)</p> <p>Delivery rate: 0 ÷ 10 ml/h, step 0.1 ml/h Delivery rate tolerance*: ±10% (below 1 ml/h after first delivered 0.05 ml)</p> <p>(*Note: In case of heparin flow below 1 ml/h, significant error can derive when the pump starts to move the plunger because of its positioning tolerances or simply due to flexibility of the plunger.)</p> <p>Working range pressure: 0 ÷ +250 mmHg</p> <p>Protection system: Status and rate of the pumps are monitored by a rotation detector.</p> <p>Alarm override: Not possible during therapy.</p>
--	--

9.4.4 Plasma Circuit

<p>Plasma/buffer pump (PBP) (marked yellow)</p> 	<p>Peristaltic roller pump with motor switch-off when the pump cover is open</p> <p>Delivery rate: $2 \div 50$ ml/min Delivery rate tolerance: $< \pm 10$ % Working range pressure: $-100 \div +450$ mmHg</p> <p>Protection system: Pump status and rate is monitored via a rotation detector.</p> <p>Alarm override: Not possible during the therapy</p> <p>Acoustic alarm interval: 120 seconds</p>
<p>Plasma pressure (PPL)</p>	<p>Electronically measured by a pressure sensor and digitally displayed</p> <p>Measurement range: $-500 \div +500$ mmHg Allowed tolerance: ± 10 mmHg Working range: $+20 \div +50$ mmHg</p> <p>During therapy: Default alarm limits: $-10 \div +200$ mmHg Lower limit adjustable in parameter setting</p> <p>Protection system: Sensor test during preparation phase.</p> <p>Alarm override: Not possible during the therapy</p> <p>Acoustic alarm interval: 120 seconds</p>
<p>Blood leak detector (BLD)</p> 	<p>Photometrical red detector on disposable tubing close to plasma filter outlet</p> <p>Sensitivity: 0.25 % (for detection of 0.5 ml blood in 200 ml fluid) Avoid direct light exposure!</p> <p>Reaction time: approx. 20 seconds</p> <p>Protection system: Automatic calibration and self-test during preparation phase and cyclic self-test during therapy. Possibility of repeating the calibration/self-test at alarm during therapy.</p> <p>Alarm override: Possibility for alarm overriding during therapy when the self-test/calibration failed three times. The therapy can be continued with monitoring by the user.</p> <p>A periodically occurring warning is maintained.</p> <p>Acoustic alarm interval: 120 seconds</p>

<p>Precipitate filter pressure (PPF)</p> 	<p>Electronically measured by a pressure sensor and digitally displayed</p> <p>Measurement range: -500 ÷ +500 mmHg Allowed tolerance: ±10 mmHg Working range: +150 ÷ +300 mmHg</p> <p>During Therapy: Default alarm limits: -20 ÷ +450 mmHg Lower limit adjustable in parameter setting</p> <p>Protection system: Sensor test during preparation phase.</p> <p>Alarm override: Not possible during the therapy</p> <p>Acoustic alarm interval: 120 seconds</p>
<p>Dialyzer pressure (PDF)</p>	<p>Electronically measured by a pressure sensor and digitally displayed</p> <p>Measurement range: -500 ÷ +500 mmHg Allowed tolerance: ± 10 mmHg Working range: +120 ÷ +270 mmHg</p> <p>During therapy: Default alarm limits: -50 ÷ +350 mmHg Parameter adjustable</p> <p>Protection system: Sensor test during preparation phase</p> <p>Alarm override: Not possible during therapy</p> <p>Acoustic alarm interval: 120 seconds</p>

9.4.5 Dialyzing Circuit

<p>Ultrafiltration pump (UFP) (marked green)</p> 	<p>Peristaltic roller pump with motor switch-off when the pump cover is open</p> <p>Delivery rate: 10 ÷ 300 ml/min Controlled by patient balance feedback control system (based on weight measurement by load cell).</p> <p>Allowed tolerance: <math>< \pm 10 \%</math> Working range pressure: -100 ÷ +450 mmHg</p> <p>Protection system: Pump status and rate is monitored via a rotation detector.</p> <p>Alarm override: Not possible during the therapy</p> <p>Acoustic alarm interval: 120 seconds</p>
<p>Dialysate pump (DP)</p> 	<p>Peristaltic roller pump with motor switch-off when the pump cover is open</p> <p>Delivery rate: 10 ÷ 200 ml/min Delivery rate tolerance: <math>< \pm 10 \%</math> Working range pressure: -140 ÷ +500 mmHg</p> <p>Protection system: Pump status and rate is monitored via a rotation detector.</p> <p>Alarm override: Not possible during the therapy</p> <p>Acoustic alarm interval: 120 seconds</p>
<p>Dialysate inlet pressure (PDI)</p>	<p>Electronically measured by a pressure sensor and digitally displayed</p> <p>Measurement range: -500 ÷ +500 mmHg Allowed tolerance: ± 10 mmHg Working range: +60 ÷ + 80 mmHg</p> <p>During therapy: Alarm limits -50 ÷ +450 mmHg</p> <p>Protection system: Sensor test during preparation phase.</p> <p>Alarm override: Not possible during the therapy</p> <p>Acoustic alarm interval: 120 s</p>
<p>Air detector (DAD)</p> 	<p>Ultrasonic sensor on the dialysate line behind the dialysate pump</p> <p>Sensitivity: Air for 800 ms</p> <p>Protection system: Sensor test during preparation phase.</p> <p>Alarm override: 40 seconds after alarm.</p> <p>Acoustic alarm interval: 120 seconds</p>

<p>Plate warmer (H)</p> 	<p>Fluid warming system with temperature sensors based on heat transfer between temperature controlled metal plate and plastic dialysate bag.</p> <p>Temperature range: 34 ÷ 40°C Default in therapy: 39°C Allowed tolerance: 0.5°C</p> <p>Upper alarm limit: 41.5 °C for 10 seconds</p> <p>Protection system: Double channel temperature monitoring with sensor test during preparation phase.</p> <p>Alarm override: Not possible during the therapy</p> <p>Acoustic alarm interval: 120 seconds</p>
---	--

9.4.6 Weight System

Load cell	<p>Loading capacity: 30 kg Weight resolution: 1 g Allowed tolerance: ± 20 g Working range: 0 – 25 kg</p> <p>Overload protection: electrically at 24.5 kg mechanically at 26 kg</p> <p>Weight change alarm: Weight deviation < 50 g: No alarm Weight deviation 50÷200 g: Alarm after 5 seconds if deviation is not corrected. Weight deviation > 200 g: Immediate alarm</p> <p>Protection system: Sensor test during preparation phase and electric current through load cell bridge monitoring during therapy.</p> <p>Alarm override: Not possible during the therapy.</p> <p>Acoustic alarm interval: 120 seconds</p>
Patient balance	<p>Patient balance feedback control system based on weight measurement by the load cell controlling the ultrafiltration pump (marked green).</p> <p>Patient balance range -600 ÷ 0 g Allowed tolerance: ± 50 g Working range: -600 ÷ 0 g</p> <p>During therapy: Alarm limits: ± 200 g Patient balance (calculated by the software from weight change) is compared continuously to the momentary theoretical value.</p> <p>Protection system: Double channel patient balance monitoring with sensor test during preparation phase.</p> <p>Alarm override: Alarm limit can be increased by 100 g by alarm acknowledge, but reaching the alarm limit ± 400 g override is not possible anymore.</p> <p>Acoustic alarm interval: 120 seconds</p>

9.5 WARRANTY AND LIABILITY

9.5.1 Manufacturer Responsibility

The manufacturer, installation company and check-out or instructor personnel consider themselves responsible for the effects on safety, reliability and performance of the machine only when installation, extensions, new settings, changes or repairs were performed by persons authorized by them, and the electrical installation of the room involved complies with the requirements of VDE 0100/VDE 010/IEC stipulations and the machine is used in accordance with the Instructions for Use.

9.5.2 Warranty and Liability

For the H.E.L.P. Plasmal® Futura, B. Braun Avitum AG grants 12 months guarantee as from the initial installation.

The guarantee comprises the repair or the replacement of defective parts, providing they have design, production or material defects.

The guarantee becomes void when the owner or third parties have performed modifications or repairs on the machine.

Excluded from the guarantee is the correction of faults which are due to incorrect handling, improper treatment and normal wear.